

PERRY®

FiXings®

FIXINGS & FASTENERS 2023

TIMBER FIXINGS · ROOFING FIXINGS · ENGINEERING FASTENERS · MASONRY FIXINGS



Contents

Timber Fixings

Page

SCREWS:

TENZ® High Performance Woodscrews	6
Perry Pro Wood Screws	8
Stainless Steel Twin Thread Wood Screws	10
Wall Plugs	10
Hex Head Coach Screws (DIN 571)	11

EXTERIOR SCREWS:

Decking Screw 17	12
Timber Screw	13

Roofing Fixings

SCREWS:

Hex Head Self Drilling Screws	14
-------------------------------	----

BOLTS:

Nylon Hex Head Cover Caps	15
Hook Bolts	15
Roofing Bolts with Square Nuts	16

Engineering Fasteners

BOLTS:

Hex Head Bolts with Nuts (DIN 931/934)	16
Hex Head Set Screws with Nuts (DIN 933/934)	17
Cup Square Bolts with Nuts (DIN 603/555)	18

NUTS:

Grade 8 Hexagonal Metric Full Nuts (DIN 934)	19
Type T Locking Nuts (DIN 985)	19
Grade 8 Hexagonal Metric Serrated Flange Nuts (DIN 6923)	20
Metric Nuts & Washers	20

WASHERS:

Square Plate Washers	20
Round Metric Washers - Form A (DIN 125-A)	21
Penny Washers (DIN 9054)	21

ASSORTMENT PACKS:

Assortment Packs	22
------------------	----

RIVETS:

Large Flange Head Pop Rivets (DIN 7337)	23
Dome Head Pop Rivets (DIN 7337)	23

Masonry Fixings

CONCRETE & MASONRY FIXINGS:

Nylon Frame Fixings (Screw Type)	24
Hex Head Concrete Bolts	24

SHIELD ANCHORS:

Eye Bolt Shield Anchors	25
Projecting Bolt Shield Anchors	25
Loose Bolt Shield Anchors	26
Sleeve Anchors	26

Nails

LOOSE NAILS:

Round Wire Nails	28
Annular Ring Shank Nails	30
Pointed (Netting) Wire Staples	31
Panel Pins	32
Oval Brad Nails	32
Square Twisted Nails	32
Clout Nails	33
Extra Large Head Clout Nails	33
Round Head Drive Screw Nails	34
Spring Head Roofing Nails	34
Dowty Type Washers (Spat Washers)	34



Fixings & Fasteners Guide

Gauge / Diameter

The gauge of the screw is determined by the size of the outside thread diameter.

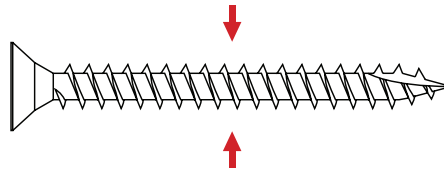

Gauge	Metric Diameter (mm) approx.	Pilot Hole Size (mm)	Masonry Rawl Plug	Hole Size for Rawl Plug (mm)
3	2.5	1	Yellow	5
4	3	1.5	Yellow	5
6	3.5	2	Red	6
8	4	2.5	Red (or Brown)	6 (or 7)
10	5	3	Brown	7
12	5.5	3.5	Brown	7
14	6.5	4	Blue	10

Thread Length

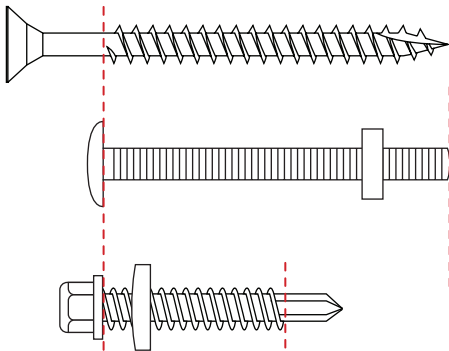

Metric (mm)	Imperial (Inch)
3.17 (3.0)	1/8"
7.94 (8.0)	5/16"
9.52 (10.0)	3/8"
12.70 (12.0)	1/2"
19.05 (19.0)	3/4"
25.40 (25.0)	1"
31.75 (32.0)	1 1/4"
38.10 (38.0)	1 1/2"
45.45 (45.0)	1 3/4"
50.80 (50.0)	2"
57.15 (57.0)	2 1/4"
63.50 (63.0)	2 1/2"
69.85 (70.0)	2 3/4"
76.20 (75.0)	3"
101.60 (100.0)	4"
127.00 (125.0)	5"
152.40 (150.0)	6"
177.80 (175.0)	7"
203.20 (200.0)	8"
228.60 (230.0)	9"
254.00 (250.0)	10"

Recess Style



POZI

Standard recess for woodscrews, chipboard screws etc.



TORX

High performance recess.

Head Types



COUNTERSUNK

For a flush finish.



HEX

Positive hex drive.

Plating & Finishes

Aluminium

Black

Bright Self Colour

Galvanised

Organic Green

Sheradised

Stainless Steel

Yellow Passivated

Zinc Plated

Corrosion Resistance Rating



NEW

ECO FRIENDLY PACKAGING
FOR 2023



PERRY
ECO INITIATIVE

ALL HANGING ITEMS ARE IN 100% RECYCLABLE PACKAGING



PERRY®



As featured in:



THE LAUNCH OF PERRY FIXINGS

A. Perry, the UK's leading supplier of architectural and agricultural hardware, is proud to announce the launch of their new range of fixings and fasteners – 'Perry Fixings'. The company has worked in close collaboration with key customers to design this new comprehensive range of fasteners complete in fully retail friendly and environmentally friendly packaging.

The Perry Fixings range has been designed to meet the needs of merchant customers, who require heavy-duty fasteners that can withstand the toughest conditions. The range includes hundreds of new items, such as Timber fixings, Roofing Bolts and Screws, Engineering Fasteners, Masonry Fixings, and re-packaged Nails. All products come with ultra-clear product labels designed to be as user-friendly as possible.

In addition to providing a comprehensive range of fixings and fasteners, A. Perry is committed to sustainable practices, and so have developed this new range upkeeping with this the environment at the forefront, replacing plastic bags with hangable cardboard boxes and have produced plastic tubs using fully recyclable materials.

Commenting on the launch of the Perry Fixings range, A. Perry's Marketing Director, Steve Perry, said, "We are delighted to be launching this exciting new range of fixings and fasteners. Our close collaboration with key customers in our targeted sector has allowed us to design a range that meets the unique needs of this market. We are also proud to be making a commitment to sustainability with our Eco-friendly packaging."



Read the full article at

www.perrytrade.co.uk/news/press-releases

in Torque Magazine Issue 73.

TENZ
from PERRY®
WOOD SCREWS

Reduced Energy Input
Drive more screws
in one full charge



Higher Performance
Effortless Screwing



Tighter Bond
Between Wood
and Screw



THE HIGH PERFORMANCE WOOD SCREW WITH STAIRS THREAD TECHNOLOGY



Scan the QR to see how
TENZ® from Perry works

TENZ® from Perry High Performance Wood Screws - Yellow Passivated



POZI



CORROSION
RESISTANCE



PLASTIC FREE
PACKAGING



No.6090PZ Retail Friendly Shelf Box

Code	Metric Size	Imperial	Finish	Box Qty	Ctn Qty	Barcode
6090PZ35-030YP	3.5mm x 30mm	No.6 x 1 1/4"	Yellow Passivated	200	9000	5023353240195
6090PZ40-025YP	4.0mm x 25mm	No.8 x 1"	Yellow Passivated	200	9000	5023353240201
6090PZ40-030YP	4.0mm x 30mm	No.8 x 1 1/4"	Yellow Passivated	200	9000	5023353240218
6090PZ40-035YP	4.0mm x 35mm	No.8 x 1 3/8"	Yellow Passivated	200	5400	5023353240225
6090PZ40-040YP	4.0mm x 40mm	No.8 x 1 1/2"	Yellow Passivated	200	5400	5023353240232
6090PZ40-045YP	4.0mm x 45mm	No.8 x 1 3/4"	Yellow Passivated	200	4800	5023353240249
6090PZ40-050YP	4.0mm x 50mm	No.8 x 2"	Yellow Passivated	200	4800	5023353240256
6090PZ40-060YP	4.0mm x 60mm	No.8 x 2 3/8"	Yellow Passivated	200	4800	5023353240263
6090PZ40-070YP	4.0mm x 70mm	No.8 x 2 3/4"	Yellow Passivated	200	4800	5023353240270
6090PZ50-040YP	5.0mm x 40mm	No.10 x 1 1/2"	Yellow Passivated	200	5400	5023353240287
6090PZ50-050YP	5.0mm x 50mm	No.10 x 2"	Yellow Passivated	200	4800	5023353240294
6090PZ50-060YP	5.0mm x 60mm	No.10 x 2 3/8"	Yellow Passivated	200	3200	5023353240300
6090PZ50-070YP	5.0mm x 70mm	No.10 x 2 3/4"	Yellow Passivated	200	3200	5023353240317
6090PZ50-080YP	5.0mm x 80mm	No.10 x 3 1/4"	Yellow Passivated	200	3200	5023353240324
6090PZ50-090YP	5.0mm x 90mm	No.10 x 3 1/2"	Yellow Passivated	100	2400	5023353240331
6090PZ50-100YP	5.0mm x 100mm	No.10 x 4"	Yellow Passivated	100	2400	5023353240348
6090PZ60-070YP	6.0mm x 70mm	No.12 x 2 3/4"	Yellow Passivated	100	2400	5023353240355
6090PZ60-080YP	6.0mm x 80mm	No.12 x 3 1/4"	Yellow Passivated	100	1600	5023353240362
6090PZ60-090YP	6.0mm x 90mm	No.12 x 3 1/2"	Yellow Passivated	100	1600	5023353240379
6090PZ60-100YP	6.0mm x 100mm	No.12 x 4"	Yellow Passivated	100	1600	5023353240386
6090PZ60-130YP	6.0mm x 130mm	No.12 x 5 1/8"	Yellow Passivated	50	1050	5023353240409
6090PZ60-150YP	6.0mm x 150mm	No.12 x 6"	Yellow Passivated	50	1050	5023353240416
6090PZ60-200YP	6.0mm x 200mm	No.12 x 8"	Yellow Passivated	25	525	5023353240423

TENZ from Perry Wood Screws

TENZ® from Perry High Performance Wood Screws - Yellow Passivated

TENZ® Stairs Thread Technology works by displacing the wood rather than cutting, tearing or milling it. This significantly reduces friction, reducing both the physical effort required by you and the energy input from the drill. Because the wood is displaced and not milled or cut, it closes in on the screw giving a firmer bond. This means you have a stronger join with less effort - No other screw can do this!

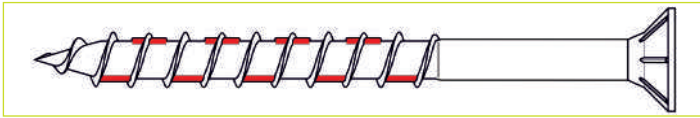

No.6090TX Retail Friendly Shelf Box

Code	Metric Size	Imperial	Finish	Box Qty	Ctn Qty	Barcode
6090TX50-070YP	5.0mm x 70mm	No.10 x 2 3/4"	Yellow Passivated	200	3200	5023353240430
6090TX50-080YP	5.0mm x 80mm	No.10 x 3 1/4"	Yellow Passivated	200	3200	5023353240447
6090TX50-100YP	5.0mm x 100mm	No.10 x 4"	Yellow Passivated	100	2400	5023353240454
6090TX60-100YP	6.0mm x 100mm	No.12 x 4"	Yellow Passivated	100	1600	5023353240461

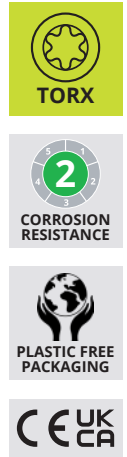

TENZ® from Perry High Performance Wood Screws - Yellow Passivated

No.6090/TUB Retail Friendly Shelf Tub

Code	Metric Size	Imperial	Finish	Pack Qty	Ctn Qty	Barcode
6090PZ40T040YP	4.0mm x 40mm	No.8 x 1 1/2"	Yellow Passivated	1000	2	5023353255786
6090PZ40T050YP	4.0mm x 50mm	No.8 x 2"	Yellow Passivated	700	2	5023353255793
6090PZ40T070YP	4.0mm x 70mm	No.8 x 2 3/4"	Yellow Passivated	500	2	5023353255816
6090PZ50T050YP	5.0mm x 50mm	No.10 x 2"	Yellow Passivated	550	2	5023353255830
6090PZ50T080YP	5.0mm x 80mm	No.10 x 3 1/4"	Yellow Passivated	300	2	5023353255861
6090PZ50T090YP	5.0mm x 90mm	No.10 x 3 1/2"	Yellow Passivated	300	2	5023353255878
6090PZ50T100YP	5.0mm x 100mm	No.10 x 4"	Yellow Passivated	200	2	5023353255885
6090PZ60T100YP	6.0mm x 100mm	No.12 x 4"	Yellow Passivated	200	2	5023353255892





COUNTERSUNK HEAD FOR FLUSH FINISH



GRIP FIT POZI HEAD FOR INCREASED TORQUE WITHOUT CAM-OUT



RIBBED HEAD FOR IMPROVED COUNTERSINKING



TYPE 17 SHARP POINT FOR FAST, EASY INSERTION, NO PRE-DRILLING REQUIRED

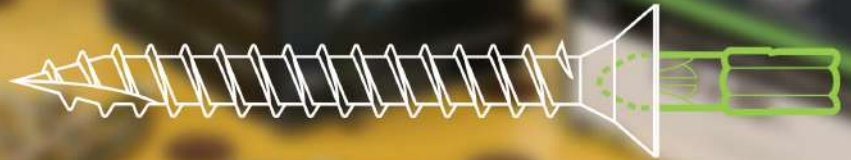

GRIP FIT
BIT INCLUDED

MULTI-PURPOSE WOODSCREWS

Perry Pro Multi-Purpose Wood Screws - Yellow Passivated



POZI



CORROSION
RESISTANCE



No.6093/AST

Retail Friendly Assortment Pack

Code	Finish	Box Qty	Ctn Qty	Barcode
6093-ATTACHE-YP	Yellow Passivated	1	6	5023353253287

1000 wood screw assortment pack containing:

- 3.5mm x 15mm - 130 screws
- 3.5mm x 25mm - 200 screws
- 4.0mm x 25mm - 120 screws
- 4.0mm x 30mm - 150 screws
- 4.0mm x 40mm - 120 screws
- 4.0mm x 50mm - 80 screws
- 5.0mm x 50mm - 65 screws
- 5.0mm x 60mm - 55 screws
- 5.0mm x 70mm - 50 screws
- 5.0mm x 80mm - 30 screws

Perry Pro Multi-Purpose Wood Screws - Yellow Passivated



POZI



CORROSION
RESISTANCE



FREE Driver Bit Included with Tub

No.6093/TUB

NEW

Retail Friendly Shelf Tub

Code	Metric Size	Imperial	Finish	Tub Qty	Ctn Qty	Barcode
6093040T040YP	4.0mm x 40mm	No.8 x 1 1/2"	Yellow Passivated	1000	4	5023353273889
6093040T050YP	4.0mm x 50mm	No.8 x 2"	Yellow Passivated	700	4	5023353273896
6093050T050YP	5.0mm x 50mm	No.10 x 2"	Yellow Passivated	550	4	5023353273902
6093050T080YP	5.0mm x 80mm	No.10 x 3 1/4"	Yellow Passivated	300	4	5023353273919
6093050T100YP	5.0mm x 100mm	No.10 x 4"	Yellow Passivated	200	4	5023353273926

Perry Pro Multi-Purpose Wood Screws

Perry Pro Multi-Purpose Wood Screws - Yellow Passivated



No.6093 Retail Friendly Shelf Box

Code	Metric Size	Imperial	Finish	Box Qty	Barcode
6093035-015YP	3.5mm x 15mm	No.6 x 5/8"	Yellow Passivated	500	5023353251573
6093035-025YP	3.5mm x 25mm	No.6 x 1"	Yellow Passivated	500	5023353251580
6093035-030YP	3.5mm x 30mm	No.6 x 1 1/4"	Yellow Passivated	200	5023353251597
6093040-025YP	4.0mm x 25mm	No.8 x 1"	Yellow Passivated	200	5023353251603
6093040-030YP	4.0mm x 30mm	No.8 x 1 1/4"	Yellow Passivated	200	5023353251610
6093040-035YP	4.0mm x 35mm	No.8 x 1 3/8"	Yellow Passivated	200	5023353251627
6093040-040YP	4.0mm x 40mm	No.8 x 1 1/2"	Yellow Passivated	200	5023353251634
6093040-045YP	4.0mm x 45mm	No.8 x 1 3/4"	Yellow Passivated	200	5023353251641
6093040-050YP	4.0mm x 50mm	No.8 x 2"	Yellow Passivated	200	5023353251658
6093040-060YP	4.0mm x 60mm	No.8 x 2 3/8"	Yellow Passivated	200	5023353251665
6093040-070YP	4.0mm x 70mm	No.8 x 2 3/4"	Yellow Passivated	200	5023353251672
6093050-040YP	5.0mm x 40mm	No.10 x 1 1/2"	Yellow Passivated	200	5023353251689
6093050-050YP	5.0mm x 50mm	No.10 x 2"	Yellow Passivated	200	5023353251696
6093050-060YP	5.0mm x 60mm	No.10 x 2 3/8"	Yellow Passivated	200	5023353251702
6093050-070YP	5.0mm x 70mm	No.10 x 2 3/4"	Yellow Passivated	200	5023353251719
6093050-080YP	5.0mm x 80mm	No.10 x 3 1/4"	Yellow Passivated	200	5023353251726
6093050-090YP	5.0mm x 90mm	No.10 x 3 1/2"	Yellow Passivated	100	5023353251733
6093050-100YP	5.0mm x 100mm	No.10 x 4"	Yellow Passivated	100	5023353251740
6093060-070YP	6.0mm x 70mm	No.12 x 2 3/4"	Yellow Passivated	100	5023353251757
6093060-080YP	6.0mm x 80mm	No.12 x 3 1/4"	Yellow Passivated	100	5023353251764
6093060-090YP	6.0mm x 90mm	No.12 x 3 1/2"	Yellow Passivated	100	5023353251771
6093060-100YP	6.0mm x 100mm	No.12 x 4"	Yellow Passivated	100	5023353251788
6093060-130YP	6.0mm x 130mm	No.12 x 5 1/8"	Yellow Passivated	50	5023353251795
6093060-150YP	6.0mm x 150mm	No.12 x 6"	Yellow Passivated	50	5023353251801
6093060-200YP	6.0mm x 200mm	No.12 x 8"	Yellow Passivated	25	5023353251818

Perry Pro Multi-Purpose Wood Screws - Zinc Plated

No.6093 **NEW** Retail Friendly Shelf Box

Code	Metric Size	Imperial	Finish	Box Qty	Barcode
6093035-030ZP	3.5mm x 30mm	No.6 x 1 1/4"	Zinc Plated	200	5023353274503
6093040-025ZP	4.0mm x 25mm	No.8 x 1"	Zinc Plated	200	5023353274510
6093040-030ZP	4.0mm x 30mm	No.8 x 1 1/4"	Zinc Plated	200	5023353274527
6093040-040ZP	4.0mm x 40mm	No.8 x 1 1/2"	Zinc Plated	200	5023353274534
6093040-050ZP	4.0mm x 50mm	No.8 x 2"	Zinc Plated	200	5023353274541
6093040-070ZP	4.0mm x 70mm	No.8 x 2 3/4"	Zinc Plated	200	5023353274558
6093050-040ZP	5.0mm x 40mm	No.10 x 1 1/2"	Zinc Plated	200	5023353274565
6093050-050ZP	5.0mm x 50mm	No.10 x 2"	Zinc Plated	200	5023353274572
6093050-080ZP	5.0mm x 80mm	No.10 x 3 1/4"	Zinc Plated	200	5023353274589
6093050-100ZP	5.0mm x 100mm	No.10 x 4"	Zinc Plated	100	5023353274596
6093060-070ZP	6.0mm x 70mm	No.12 x 2 3/4"	Zinc Plated	100	5023353274602
6093060-100ZP	6.0mm x 100mm	No.12 x 4"	Zinc Plated	100	5023353274619

Perry Pro Multi-Purpose Wood Screws - Yellow Passivated

No.6093/PP Retail Friendly Hanging Box

Code	Metric Size	Imperial	Finish	Pack Qty	Packs per Box	Barcode
6093PP040-025YP	4.0mm x 25mm	No.8 x 1"	Yellow Passivated	40	10	5023353253058
6093PP040-030YP	4.0mm x 30mm	No.8 x 1 1/4"	Yellow Passivated	40	10	5023353253065
6093PP040-040YP	4.0mm x 40mm	No.8 x 1 1/2"	Yellow Passivated	30	10	5023353253089
6093PP040-050YP	4.0mm x 50mm	No.8 x 2"	Yellow Passivated	25	10	5023353253102
6093PP040-060YP	4.0mm x 60mm	No.8 x 2 3/8"	Yellow Passivated	25	10	5023353253119
6093PP040-070YP	4.0mm x 70mm	No.8 x 2 3/4"	Yellow Passivated	25	10	5023353253126
6093PP050-040YP	5.0mm x 40mm	No.10 x 1 1/2"	Yellow Passivated	20	10	5023353253133
6093PP050-050YP	5.0mm x 50mm	No.10 x 2"	Yellow Passivated	20	10	5023353253140
6093PP050-070YP	5.0mm x 70mm	No.10 x 2 3/4"	Yellow Passivated	20	10	5023353253164
6093PP050-080YP	5.0mm x 80mm	No.10 x 3 1/4"	Yellow Passivated	20	10	5023353253171
6093PP050-100YP	5.0mm x 100mm	No.10 x 4"	Yellow Passivated	15	10	5023353253195
6093PP060-100YP	6.0mm x 100mm	No.12 x 4"	Yellow Passivated	10	10	5023353253232



Stainless Steel Wood Screws

Stainless Steel Twin Thread Wood Screws

Made from Grade A2/304 Stainless Steel, this multi-purpose screw has added corrosion resistant properties allowing it to be used outdoors.



No.6000/SS **NEW** Retail Friendly Shelf Box

Code	Metric Size	Imperial	Finish	Box Qty	Barcode
6000S08-020SS	4mm x 20mm	No.8 x 3/4"	Stainless Steel	200	5023353257858
6000S08-040SS	4mm x 40mm	No.8 x 1 1/2"	Stainless Steel	200	5023353257865
6000S10-030SS	5mm x 30mm	No.10 x 1 1/4"	Stainless Steel	200	5023353257872
6000S10-075SS	5mm x 75mm	No.10 x 3"	Stainless Steel	200	5023353257889
6000S10-100SS	5mm x 100mm	No.10 x 4"	Stainless Steel	100	5023353257896
6000S12-100SS	6mm x 100mm	No.12 x 4"	Stainless Steel	100	5023353257902

No.6000/SS/PP **NEW** Retail Friendly Hanging Box

Code	Metric Size	Imperial	Finish	Pack Qty	Packs per Box	Barcode
6000SPP08-020SS	4mm x 20mm	No.8 x 3/4"	Stainless Steel	40	6	5023353250682
6000SPP08-040SS	4mm x 40mm	No.8 x 1 1/2"	Stainless Steel	30	6	5023353250699
6000SPP10-030SS	5mm x 30mm	No.10 x 1 1/4"	Stainless Steel	25	6	5023353250705
6000SPP10-075SS	5mm x 75mm	No.10 x 3"	Stainless Steel	25	6	5023353251016
6000SPP10-100SS	5mm x 100mm	No.10 x 4"	Stainless Steel	20	6	5023353251023
6000SPP12-100SS	6mm x 100mm	No.12 x 4"	Stainless Steel	15	6	5023353251030

Stainless Steel finished screws offer several benefits, including:

Corrosion Resistance

Stainless Steel screws are highly resistant to corrosion, which makes them ideal for use in environments that are prone to moisture or other harsh conditions.

Strength

Stainless Steel is a strong material, which makes it ideal for use in applications where the screws will be subjected to high stress or tension.

Aesthetic Appeal

Stainless Steel finished screws have a sleek, modern look that can enhance the appearance of a project or product.

Durability

Stainless Steel screws are highly durable and can withstand exposure to extreme temperatures, chemicals, and other harsh conditions.

Non-Magnetic Properties

Stainless Steel screws are non-magnetic, which makes them ideal for use in applications where magnetic interference can be a problem.

Easy Maintenance

Stainless Steel finished screws require little maintenance, making them a low-maintenance option for many applications.

Wall Plugs

A standard wall plug suitable for concrete and masonry. Ideal for use on medium and lightweight applications.



No.6050 **NEW** Retail Friendly Shelf Box

Code	Size	Finish	Box Qty	Barcode
60500006RD	5.5mm	Red	100	5023353281839
60500007BR	7mm	Brown	100	5060194330982

No.6050/NY **NEW** Retail Friendly Shelf Box

Code	Size	Finish	Box Qty	Barcode
6050NY0010GY	10mm x 50mm	Grey	50	5023353258220

TIMBER FIXINGS
ROOFING FIXINGS
ENGINEERED FASTENERS
MASONRY FIXINGS
NAILS

Hex Head Coach Screws

Hex Head Coach Screws (DIN 571) - Zinc Plated

Ideal for fixing items to timber, or into masonry when using a nylon wall plug (not included). Also known as Lag Screws or Lag Bolts.

No.6025 **NEW** Retail Friendly Shelf Box

Code	Size	Finish	Box Qty	Ctn Qty	Barcode
602508-040ZP	M8 x 40mm	BZP-E/Galv	200	800	5023353079047
602508-050ZP	M8 x 50mm	BZP-E/Galv	200	600	5023353139673
602508-075ZP	M8 x 75mm	BZP-E/Galv	100	400	5023353079184
602508-100ZP	M8 x 100mm	BZP-E/Galv	100	300	5023353141010
602510-050ZP	M10 x 50mm	BZP-E/Galv	100	400	5023353079412
602510-075ZP	M10 x 75mm	BZP-E/Galv	100	300	5050420042086
602510-100ZP	M10 x 100mm	BZP-E/Galv	100	200	5050420042116
602510-150ZP	M10 x 150mm	BZP-E/Galv	50	150	5023353203626
602512-050ZP	M12 x 50mm	BZP-E/Galv	50	300	5023353088476
602512-075ZP	M12 x 75mm	BZP-E/Galv	50	150	5023353079825
602512-100ZP	M12 x 100mm	BZP-E/Galv	50	150	5023353141126
602512-150ZP	M12 x 150mm	BZP-E/Galv	25	75	5023353141140



No.6025/PP **NEW** Retail Friendly Hanging Box

Code	Size	Finish	Pack Qty	Packs per Box	Barcode
6025PP08-040P010ZP	M8 x 40mm	BZP-E/Galv	10	6	5023353191282
6025PP08-050P010ZP	M8 x 50mm	BZP-E/Galv	10	6	5023353191299
6025PP08-075P010ZP	M8 x 75mm	BZP-E/Galv	10	6	5023353191336
6025PP08-100P010ZP	M8 x 100mm	BZP-E/Galv	10	6	5023353191367
6025PP10-050P005ZP	M10 x 50mm	BZP-E/Galv	5	6	5023353191503
6025PP10-075P005ZP	M10 x 75mm	BZP-E/Galv	5	6	5023353191541
6025PP10-100P005ZP	M10 x 100mm	BZP-E/Galv	5	6	5023353191572
6025PP10-150P005ZP	M10 x 150mm	BZP-E/Galv	5	5	5023353191602
6025PP12-050P005ZP	M12 x 50mm	BZP-E/Galv	5	6	5023353191633
6025PP12-075P005ZP	M12 x 75mm	BZP-E/Galv	5	6	5023353191671
6025PP12-100P005ZP	M12 x 100mm	BZP-E/Galv	5	6	5023353191701
6025PP12-150P005ZP	M12 x 150mm	BZP-E/Galv	5	5	5023353191725



Hex Head Coach Screws (DIN 571) - Galvanised

No.6025 **NEW** Retail Friendly Shelf Box

Code	Size	Finish	Box Qty	Ctn Qty	Barcode
602510-050GV	M10 x 50mm	Galv'd	100	400	5023353257667
602510-075GV	M10 x 75mm	Galv'd	100	300	5023353275456
602510-100GV	M10 x 100mm	Galv'd	100	200	5023353257650



No.6025/PP **NEW** Retail Friendly Hanging Box

Code	Size	Finish	Pack Qty	Packs per Box	Barcode
6025PP10-050P005GV	M10 x 50mm	Galv'd	5	6	5023353257681
6025PP10-075P005GV	M10 x 75mm	Galv'd	5	6	5023353250859
6025PP10-100P005GV	M10 x 100mm	Galv'd	5	6	5023353257674



Decking Screws & Timber Screws

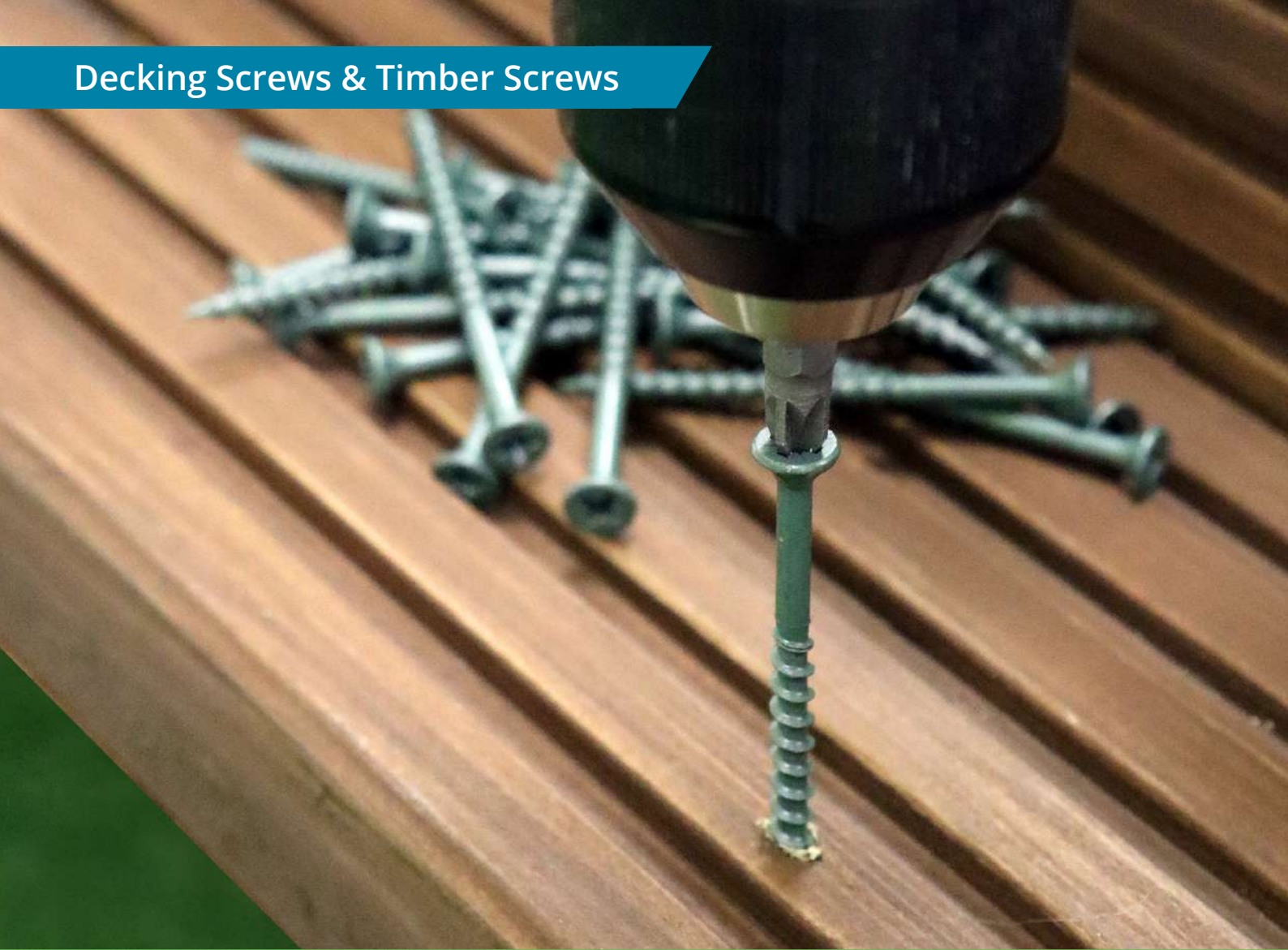

Decking Screw 17 - Organic Green



Weather Protected
1000 hours salt spray tested



Rapid Type 17 Point
for fast insertion



Self Countersinking
Double Angle Head



Sharp Angle Thread
for screwing efficiency

No.6012

Retail Friendly Shelf Box
Contains a free driver bit

Code	Size	Finish	Box Qty	Ctn Qty	Barcode
601245-050GN17	4.5mm x 50mm	Organic Green	200	3600	5023353108877
601245-060GN17	4.5mm x 60mm	Organic Green	200	3200	5023353108891
601245-075GN17	4.5mm x 75mm	Organic Green	200	1600	5023353108914

No.6012/PP

NEW

Retail Friendly Hanging Box
Contains a free driver bit

Code	Size	Finish	Pack Qty	Packs per Box	Barcode
6012PP45-050P025GN17	4.5mm x 50mm	Organic Green	25	6	5023353182815
6012PP45-060P020GN17	4.5mm x 60mm	Organic Green	20	6	5023353182822
6012PP45-075P040GN17	4.5mm x 75mm	Organic Green	40	6	5023353182839

Decking Screws & Timber Screws

Decking Screw 17 - Organic Green

Our Decking Screw 17 is a high performance screw designed for ease and speed when used with a suitable power tool. The improved Type 17 point gives quick penetration into some of the hardest woods as well as self clearing wood swarf giving this screw the edge over other Decking Screws on the market.

- Each box contains a free driver bit



Weather Protected
1000 hours salt spray tested



Rapid Type 17 Point
for fast insertion



Self Countersinking
Double Angle Head



Sharp Angle Thread
for screwing efficiency

No.6012/T Retail Friendly Shelf Tub

Code	Size	Finish	Pack Qty	Ctn Qty	Barcode
6012T45-050GN17	4.5mm x 50mm	Organic Green	1000	2	5023353240539
6012T45-060GN17	4.5mm x 60mm	Organic Green	800	2	5023353240546
6012T45-075GN17	4.5mm x 75mm	Organic Green	550	2	5023353240553



Timber Screw - Organic Green

The No.6016 TimberScrew is a high performance fixing that can be used on beams, rafters, stairs, joists, timber decking, fencing, wooden landscape timber walls and much more.

- Each box contains a free driver bit
- Additional bits are available (No.6021/H)



Weather Protected
1000 hours salt spray tested

No.6016 Retail Friendly Shelf Box

Code	Size	Finish	Box Qty	Ctn Qty	Barcode
6016-0075GN	75mm	Organic Green	100	600	5023353246159
6016-0100GN	100mm	Organic Green	100	600	5023353246166
6016-0150GN	150mm	Organic Green	100	600	5023353246173
6016-0200GN	200mm	Organic Green	100	500	5023353246180
6016-0250GN	250mm	Organic Green	100	400	5023353246197



No.6016/PP Retail Friendly Hanging Box

Code	Size	Finish	Pack Qty	Ctn Qty	Barcode
6016PP-0075GN	75mm	Organic Green	25	12	5023353246258
6016PP-0100GN	100mm	Organic Green	25	12	5023353246265
6016PP-0150GN	150mm	Organic Green	25	12	5023353246272
6016PP-0200GN	200mm	Organic Green	10	12	5023353246289
6016PP-0250GN	250mm	Organic Green	10	12	5023353246296

Hex Head Self Drilling Screws

Hex Head Self Drilling Screw for Timber Roofing - Zinc Plated

Used for fixing roofing sheets to timber frames. As the Hex Head Self-Drilling Screw is driven in, the washer compresses making the hole watertight.



HEX



2
CORROSION RESISTANCE



PLASTIC FREE PACKAGING

FOR TIMBER ROOFS



No.6071 **NEW** Retail Friendly Shelf Box

Code	Size	Finish	Box Qty	Ctn Qty	Barcode
607163-032ZP	6.3mm x 32mm	BZP-E/Galv	100	1600	5023353182884
607163-045ZP	6.3mm x 45mm	BZP-E/Galv	100	1200	5023353182891
607163-060ZP	6.3mm x 60mm	BZP-E/Galv	100	800	5023353257957
607163-080ZP	6.3mm x 80mm	BZP-E/Galv	100	600	5023353257964

No.6071/PP **NEW** Retail Friendly Hanging Box

Code	Size	Finish	Pack Qty	Packs per Box	Barcode
6071PP63-032P020ZP	6.3mm x 32mm	BZP-E/Galv	20	6	5023353250866
6071PP63-045P015ZP	6.3mm x 45mm	BZP-E/Galv	15	6	5023353251061
6071PP63-060P010ZP	6.3mm x 60mm	BZP-E/Galv	10	6	5023353250880
6071PP63-080P008ZP	6.3mm x 80mm	BZP-E/Galv	8	6	5023353257766



Hex Head Self Drilling Screw for Steel Roofing - Zinc Plated

Used for fixing roofing sheets to steel frames (up to 5mm thick). As the Hex Head Self-Drilling Screw is driven in, the washer compresses making the hole watertight.



HEX



2
CORROSION RESISTANCE



PLASTIC FREE PACKAGING

FOR STEEL ROOFS



No.6073 **NEW** Retail Friendly Shelf Box

Code	Size	Finish	Box Qty	Ctn Qty	Barcode
607348-020ZP	4.8mm x 20mm	BZP-E/Galv	100	3200	5023353257933
607355-025ZP	5.5mm x 25mm	BZP-E/Galv	100	1500	5023353183058
607355-032ZP	5.5mm x 32mm	BZP-E/Galv	100	1500	5023353183065
607355-038ZP	5.5mm x 38mm	BZP-E/Galv	100	1600	5023353183072
607355-048ZP	5.5mm x 48mm	BZP-E/Galv	100	1200	5023353275463
607363-022ZP	6.3mm x 22mm	BZP-E/Galv	100	1500	5023353257940

No.6073/PP **NEW** Retail Friendly Hanging Box

Code	Size	Finish	Pack Qty	Packs per Box	Barcode
6073PP48-020P020ZP	4.8mm x 20mm	BZP-E/Galv	20	6	5023353250941
6073PP55-025P020ZP	5.5mm x 25mm	BZP-E/Galv	20	6	5023353250903
6073PP55-032P020ZP	5.5mm x 32mm	BZP-E/Galv	20	6	5023353183010
6073PP55-038P020ZP	5.5mm x 38mm	BZP-E/Galv	20	6	5023353250927
6073PP55-048P020ZP	5.5mm x 48mm	BZP-E/Galv	20	6	5023353250958
6073PP63-022P020ZP	6.3mm x 22mm	BZP-E/Galv	20	6	5023353250972



Cover Caps & Hook Bolts

Nylon Hex Head Cover Caps - Black & Green

Used to blend in roofing and construction screws with the panel. Ideal for use with No.6071 and No.6073 Hex Head Self Drilling Screws.

No.6076/PP **NEW** Retail Friendly Hanging Box

Code	Size	Finish	Pack Qty	Packs per Box	Barcode
6076PP08-016P035BK	8 x 16mm	Black	35	36	5023353187650
6076PP08-016P035GN	8 x 16mm	Green	35	36	5023353187667



Hook Bolts - Yellow Passivated

Used to suspend wires, cables, chain and other similar items. Supplied with square nuts.

No.434 **NEW** Retail Friendly Shelf Box

Code	Size	Finish	Box Qty	Barcode
434-08-120YP	M8 x 120mm	Yellow Passivated	100	5023353258251
434-08-160YP	M8 x 160mm	Yellow Passivated	100	5023353258268
434-08-180YP	M8 x 180mm	Yellow Passivated	100	5023353258275
434-08-220YP	M8 x 220mm	Yellow Passivated	100	5023353258282



No.434/PP **NEW** Retail Friendly Hanging Box

Code	Size	Finish	Pack Qty	Packs per Box	Barcode
434-PP08-120YP	M8 x 120mm	Yellow Passivated	10	5	5023353258305
434-PP08-160YP	M8 x 160mm	Yellow Passivated	10	5	5023353258282
434-PP08-180YP	M8 x 180mm	Yellow Passivated	10	5	5023353258285
434-PP08-220YP	M8 x 220mm	Yellow Passivated	10	5	5023353258299



Roofing Bolts & Hex Head Bolts

Roofing Bolts with Square Nuts - Zinc Plated

Used to secure or clamp metal, plastic or wood sheeting.



No.2786 **NEW** Retail Friendly Shelf Box

Code	Size	Finish	Box Qty	Barcode
278606-025ZP	M6 x 25mm	BZP-E/Galv	100	5023353054402
278606-040ZP	M6 x 40mm	BZP-E/Galv	100	5023353051999
278606-050ZP	M6 x 50mm	BZP-E/Galv	100	5023353054464
278606-070ZP	M6 x 70mm	BZP-E/Galv	100	5023353052057
278606-100ZP	M6 x 100mm	BZP-E/Galv	100	5023353052095
278608-050ZP	M8 x 50mm	BZP-E/Galv	100	5023353076992
278608-100ZP	M8 x 100mm	BZP-E/Galv	50	5023353077098

No.2786/PP **NEW** Retail Friendly Hanging Box

Code	Size	Finish	Pack Qty	Packs per Box	Barcode
2786PP06-025P020ZP	M6 x 25mm	BZP-E/Galv	20	6	5023353190667
2786PP06-040P020ZP	M6 x 40mm	BZP-E/Galv	20	6	5023353190698
2786PP06-050P020ZP	M6 x 50mm	BZP-E/Galv	20	6	5023353190704
2786PP06-070P020ZP	M6 x 70mm	BZP-E/Galv	20	6	5023353190728
2786PP06-100P020ZP	M6 x 100mm	BZP-E/Galv	20	5	5023353190742
2786PP08-050P015ZP	M8 x 50mm	BZP-E/Galv	15	6	5023353281761
2786PP08-100P015ZP	M8 x 100mm	BZP-E/Galv	15	5	5023353281778

Hex Head Bolts with Nuts (DIN 931/934) - Zinc Plated

A Grade 8.8 heavy duty bolts with a hexagonal head that can be tightened with a spanner, wrench or pliers. The shank is partly threaded.



No.6023 **NEW** Retail Friendly Shelf Box

Code	Size	Finish	Box Qty	Ctn Qty	Barcode
602308-050ZP	M8 x 50mm	BZP-E/Galv	200	600	5023353281440
602308-100ZP	M8 x 100mm	BZP-E/Galv	100	300	5023353226748
602310-050ZP	M10 x 50mm	BZP-E/Galv	100	300	5023353281457
602310-100ZP	M10 x 100mm	BZP-E/Galv	50	150	5023353213922
602312-050ZP	M12 x 50mm	BZP-E/Galv	100	200	5023353281471
602312-100ZP	M12 x 100mm	BZP-E/Galv	50	150	5023353281488

No.6023/PP **NEW** Retail Friendly Hanging Box

Code	Size	Finish	Pack Qty	Packs per Box	Barcode
6023PP08-050P010ZP	M8 x 50mm	BZP-E/Galv	10	6	5023353281464
6023PP08-100P010ZP	M8 x 100mm	BZP-E/Galv	10	6	5023353281495
6023PP10-050P005ZP	M10 x 50mm	BZP-E/Galv	5	6	5023353281501
6023PP10-100P005ZP	M10 x 100mm	BZP-E/Galv	5	6	5023353281518
6023PP12-050P005ZP	M12 x 50mm	BZP-E/Galv	5	6	5023353281525
6023PP12-100P005ZP	M12 x 100mm	BZP-E/Galv	5	5	5023353281532

TIMBER FIXINGS
ENGINEERED FASTENERS
MASONRY FIXINGS
NAILS

Hex Head Set Screws with Nuts (DIN 933/934) - Zinc Plated

A fully threaded heavy duty bolt with a hexagonal head made from Grade 8.8 Steel.

No.6024 **NEW** Retail Friendly Shelf Box

Code	Size	Finish	Box Qty	Ctn Qty	Barcode
602406-025ZP	M6 x 25mm	BZP-E/Galv	200	1600	5023353258060
602406-040ZP	M6 x 40mm	BZP-E/Galv	200	800	5023353258077
602406-050ZP	M6 x 50mm	BZP-E/Galv	200	800	5023353258084
602406-080ZP	M6 x 80mm	BZP-E/Galv	100	400	5023353257278
602408-025ZP	M8 x 25mm	BZP-E/Galv	200	800	5023353258091
602408-040ZP	M8 x 40mm	BZP-E/Galv	200	600	5023353224720
602408-050ZP	M8 x 50mm	BZP-E/Galv	200	600	5023353224843
602408-080ZP	M8 x 80mm	BZP-E/Galv	100	400	5023353257285
602408-100ZP	M8 x 100mm	BZP-E/Galv	100	300	5023353258107
602410-025ZP	M10 x 25mm	BZP-E/Galv	200	400	5023353206252
602410-040ZP	M10 x 40mm	BZP-E/Galv	100	300	5023353205422
602410-050ZP	M10 x 50mm	BZP-E/Galv	100	300	5023353211911
602410-075ZP	M10 x 75mm	BZP-E/Galv	100	200	5023353258114
602410-100ZP	M10 x 100mm	BZP-E/Galv	50	150	5023353258121
602410-120ZP	M10 x 120mm	BZP-E/Galv	50	150	5023353203787
602410-140ZP	M10 x 140mm	BZP-E/Galv	50	150	5023353257292
602412-025ZP	M12 x 25mm	BZP-E/Galv	100	300	5023353258138
602412-040ZP	M12 x 40mm	BZP-E/Galv	100	300	5023353224713
602412-050ZP	M12 x 50mm	BZP-E/Galv	100	200	5023353258145
602412-075ZP	M12 x 75mm	BZP-E/Galv	50	200	5023353205347
602412-100ZP	M12 x 100mm	BZP-E/Galv	50	150	5023353258152
602412-120ZP	M12 x 120mm	BZP-E/Galv	50	100	5023353258169
602412-140ZP	M12 x 140mm	BZP-E/Galv	50	100	5023353258176
602412-160ZP	M12 x 160mm	BZP-E/Galv	25	75	5023353257308
602412-200ZP	M12 x 200mm	BZP-E/Galv	25	75	5023353257315
602416-050ZP	M16 x 50mm	BZP-E/Galv	25	100	5023353239106
602416-075ZP	M16 x 75mm	BZP-E/Galv	25	100	5023353208386
602416-100ZP	M16 x 100mm	BZP-E/Galv	25	75	5023353281167
602416-150ZP	M16 x 150mm	BZP-E/Galv	25	100	5023353281266



No.6024/PP **NEW** Retail Friendly Hanging Box

Code	Size	Finish	Pack Qty	Packs per Box	Barcode
6024PP06-025P010ZP	M6 x 25mm	BZP-E/Galv	10	6	5023353257018
6024PP06-040P010ZP	M6 x 40mm	BZP-E/Galv	10	6	5023353257025
6024PP06-050P010ZP	M6 x 50mm	BZP-E/Galv	10	6	5023353257032
6024PP06-080P010ZP	M6 x 80mm	BZP-E/Galv	10	6	5023353257216
6024PP08-025P010ZP	M8 x 25mm	BZP-E/Galv	10	6	5023353257049
6024PP08-040P010ZP	M8 x 40mm	BZP-E/Galv	10	6	5023353257056
6024PP08-050P010ZP	M8 x 50mm	BZP-E/Galv	10	6	5023353257063
6024PP08-080P010ZP	M8 x 80mm	BZP-E/Galv	10	6	5023353257223
6024PP08-100P010ZP	M8 x 100mm	BZP-E/Galv	10	6	5023353257070
6024PP10-025P005ZP	M10 x 25mm	BZP-E/Galv	5	6	5023353257087
6024PP10-040P005ZP	M10 x 40mm	BZP-E/Galv	5	6	5023353257094
6024PP10-050P005ZP	M10 x 50mm	BZP-E/Galv	5	6	5023353257100
6024PP10-075P005ZP	M10 x 75mm	BZP-E/Galv	5	6	5023353250811
6024PP10-100P005ZP	M10 x 100mm	BZP-E/Galv	5	6	5023353257117
6024PP10-120P005ZP	M10 x 120mm	BZP-E/Galv	5	5	5023353257124
6024PP10-140P005ZP	M10 x 140mm	BZP-E/Galv	5	5	5023353257230
6024PP12-025P005ZP	M12 x 25mm	BZP-E/Galv	5	6	5023353257131
6024PP12-040P005ZP	M12 x 40mm	BZP-E/Galv	5	6	5023353257148
6024PP12-050P005ZP	M12 x 50mm	BZP-E/Galv	5	6	5023353257155
6024PP12-075P005ZP	M12 x 75mm	BZP-E/Galv	5	6	5023353257162
6024PP12-100P005ZP	M12 x 100mm	BZP-E/Galv	5	5	5023353257179
6024PP12-120P005ZP	M12 x 120mm	BZP-E/Galv	5	5	5023353257186
6024PP12-140P005ZP	M12 x 140mm	BZP-E/Galv	5	5	5023353257193
6024PP12-160P005ZP	M12 x 160mm	BZP-E/Galv	5	5	5023353257247
6024PP12-200P005ZP	M12 x 200mm	BZP-E/Galv	5	5	5023353257254
6024PP16-050P002ZP	M16 x 50mm	BZP-E/Galv	2	6	5023353257209
6024PP16-075P005ZP	M16 x 75mm	BZP-E/Galv	5	5	5023353281273
6024PP16-100P004ZP	M16 x 100mm	BZP-E/Galv	4	5	5023353281280
6024PP16-150P003ZP	M16 x 150mm	BZP-E/Galv	3	5	5023353281297



Cup Square Bolts

Cup Square Bolts with Nuts (DIN 603/555) - Zinc Plated

A security bolt that has a square section under the domed head that prevents the bolt from being twisted loose from the outside. Commonly used when fixing ironmongery to timber. Supplied with Hexagonal Nuts to suit. Also known as Carriage Bolts.

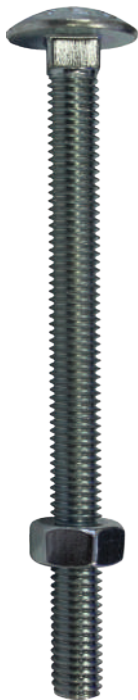
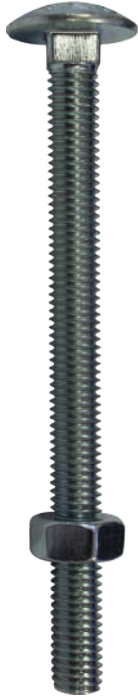

No.6026 **NEW** Retail Friendly Shelf Box

Code	Size	Finish	Box Qty	Ctn Qty	Barcode
602606-040ZP	M6 x 40mm	BZP-E/Galv	200	800	5023353074448
602606-065ZP	M6 x 65mm	BZP-E/Galv	100	800	5023353074547
602606-100ZP	M6 x 100mm	BZP-E/Galv	100	400	5023353074646
602606-150ZP	M6 x 150mm	BZP-E/Galv	100	300	5023353074745
602608-050ZP	M8 x 50mm	BZP-E/Galv	100	400	5023353074882
602608-075ZP	M8 x 75mm	BZP-E/Galv	100	300	5023353074981
602608-090ZP	M8 x 90mm	BZP-E/Galv	50	400	5023353075025
602608-110ZP	M8 x 110mm	BZP-E/Galv	50	200	5023353075070
602608-150ZP	M8 x 150mm	BZP-E/Galv	50	150	5023353075155
602610-065ZP	M10 x 65mm	BZP-E/Galv	50	200	5023353075407
602610-075ZP	M10 x 75mm	BZP-E/Galv	50	150	5023353075445
602610-100ZP	M10 x 100mm	BZP-E/Galv	50	150	5023353075506
602610-110ZP	M10 x 110mm	BZP-E/Galv	50	150	5023353075520
602610-150ZP	M10 x 150mm	BZP-E/Galv	50	150	5023353075605
602610-180ZP	M10 x 180mm	BZP-E/Galv	50	100	5023353075643
602610-200ZP	M10 x 200mm	BZP-E/Galv	50	100	5023353075674
602612-075ZP	M12 x 75mm	BZP-E/Galv	50	150	5023353075995
602612-100ZP	M12 x 100mm	BZP-E/Galv	25	100	5050420014892
602612-110ZP	M12 x 110mm	BZP-E/Galv	25	100	5023353076077
602612-150ZP	M12 x 150mm	BZP-E/Galv	25	75	5023353076152
602612-200ZP	M12 x 200mm	BZP-E/Galv	25	75	5023353076213

No.6026/PP **NEW** Retail Friendly Hanging Box

Code	Size	Finish	Pack Qty	Packs per Box	Barcode
6026PP06-040P10ZP	M6 x 40mm	BZP-E/Galv	10	6	5023353189340
6026PP06-065P10ZP	M6 x 65mm	BZP-E/Galv	10	6	5023353189395
6026PP06-100P10ZP	M6 x 100mm	BZP-E/Galv	10	6	5023353189449
6026PP06-150P10ZP	M6 x 150mm	BZP-E/Galv	10	5	5023353189487
6026PP08-050P10ZP	M8 x 50mm	BZP-E/Galv	10	6	5023353189555
6026PP08-075P10ZP	M8 x 75mm	BZP-E/Galv	10	6	5023353189609
6026PP08-090P10ZP	M8 x 90mm	BZP-E/Galv	10	6	5023353189623
6026PP08-110P10ZP	M8 x 110mm	BZP-E/Galv	10	5	5023353189647
6026PP08-150P10ZP	M8 x 150mm	BZP-E/Galv	10	5	5023353189685
6026PP10-065P005ZP	M10 x 65mm	BZP-E/Galv	5	6	5023353189814
6026PP10-075P005ZP	M10 x 75mm	BZP-E/Galv	5	6	5023353189838
6026PP10-100P005ZP	M10 x 100mm	BZP-E/Galv	5	5	5023353189869
6026PP10-110P005ZP	M10 x 110mm	BZP-E/Galv	5	5	5023353189876
6026PP10-150P005ZP	M10 x 150mm	BZP-E/Galv	5	5	5023353189913
6026PP10-180P005ZP	M10 x 180mm	BZP-E/Galv	5	5	5023353189937
6026PP10-200P005ZP	M10 x 200mm	BZP-E/Galv	5	5	5023353189944
6026PP12-075P005ZP	M12 x 75mm	BZP-E/Galv	5	5	5023353190070
6026PP12-100P005ZP	M12 x 100mm	BZP-E/Galv	5	5	5023353190100
6026PP12-110P005ZP	M12 x 110mm	BZP-E/Galv	5	5	5023353190117
6026PP12-150P005ZP	M12 x 150mm	BZP-E/Galv	5	5	5023353190155
6026PP12-200P002ZP	M12 x 200mm	BZP-E/Galv	2	5	5023353190186

TIMBER FIXINGS
ROOFING FIXINGS
ENGINEERED FASTENERS
MASONRY FIXINGS
NAILS

Grade 8 Hexagonal Metric Full Nuts (DIN 934) - Zinc Plated

A standard nut used for bolting and fastening, made from made from Grade 8 Steel to suit metric threads.

No.6400 **NEW** Retail Friendly Shelf Box

Code	Size	Finish	Box Qty	Ctn Qty	Barcode
6400-006ZP	M6	BZP-E/Galv	200	6400	5023353257557
6400-008ZP	M8	BZP-E/Galv	200	3200	5023353095986
6400-010ZP	M10	BZP-E/Galv	100	1500	5023353096006
6400-012ZP	M12	BZP-E/Galv	100	800	5023353096020
6400-016ZP	M16	BZP-E/Galv	100	400	5023353139468
6400-020ZP	M20	BZP-E/Galv	50	200	5023353139345
6400-024ZP	M24	BZP-E/Galv	25	100	5023353235641

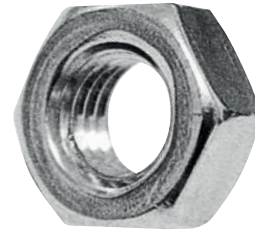

CORROSION RESISTANCE



PLASTIC FREE PACKAGING

No.6400/PP **NEW** Retail Friendly Hanging Box

Code	Size	Finish	Pack Qty	Packs per Box	Barcode
6400PP-006P060ZP	M6	BZP-E/Galv	60	6	5023353190254
6400PP-008P035ZP	M8	BZP-E/Galv	35	6	5023353190261
6400PP-010P015ZP	M10	BZP-E/Galv	15	6	5023353190278
6400PP-012P020ZP	M12	BZP-E/Galv	20	6	5023353190285
6400PP-016P010ZP	M16	BZP-E/Galv	10	6	5023353190292
6400PP-020P010ZP	M20	BZP-E/Galv	10	5	5023353190308
6400PP-024P006ZP	M24	BZP-E/Galv	6	5	5023353258312

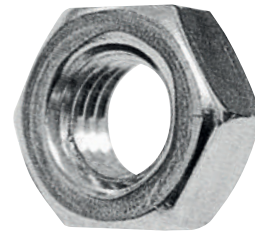

Type T Locking Nuts (DIN 985) - Zinc Plated

A hexagonal locking nut with a nylon insert that is designed to resist loosening from vibrations once tightened.

No.6020T **NEW** Retail Friendly Shelf Box

Code	Size	Finish	Box Qty	Ctn Qty	Barcode
6020T006ZP	M6	BZP-E/Galv	200	6400	5023353148095
6020T008ZP	M8	BZP-E/Galv	200	3000	5023353071539
6020T010ZP	M10	BZP-E/Galv	100	1500	5023353148132
6020T012ZP	M12	BZP-E/Galv	100	800	5023353148149
6020T016ZP	M16	BZP-E/Galv	50	400	5023353228117
6020T020ZP	M20	BZP-E/Galv	25	200	5023353148224



CORROSION RESISTANCE



PLASTIC FREE PACKAGING

No.6020T/PP **NEW** Retail Friendly Hanging Box

Code	Size	Finish	Pack Qty	Packs per Box	Barcode
6020TTP-006P050ZP	M6	BZP-E/Galv	50	6	5023353190353
6020TTP-008P025ZP	M8	BZP-E/Galv	25	6	5023353190360
6020TTP-010P010ZP	M10	BZP-E/Galv	10	6	5023353190377
6020TTP-012P020ZP	M12	BZP-E/Galv	20	6	5023353190384
6020TTP-016P010ZP	M16	BZP-E/Galv	10	6	5023353190391
6020TTP-020P010ZP	M20	BZP-E/Galv	10	5	5023353190407



Metric Nuts & Washers, Square Plate Washers

Grade 8 Hexagonal Metric Serrated Flange Nuts (DIN 6923) - Zinc Plated

Designed to provide a larger clamping and locking force than a standard hex nut.



No.6414 **NEW** Retail Friendly Shelf Box

Code	Size	Finish	Box Qty	Ctn Qty	Barcode
6414-006ZP	M6	BZP-E/Galv	200	6400	5023353281310
6414-008ZP	M8	BZP-E/Galv	200	3200	5023353281327
6414-010ZP	M10	BZP-E/Galv	100	1500	5023353281303
6414-012ZP	M12	BZP-E/Galv	100	800	5023353281334
6414-016ZP	M16	BZP-E/Galv	100	400	5023353281341
6414-020ZP	M20	BZP-E/Galv	50	200	5023353281358



No.6414/PP **NEW** Retail Friendly Hanging Box

Code	Size	Finish	Pack Qty	Packs per Box	Barcode
6414PP-006P050ZP	M6	BZP-E/Galv	50	6	5023353281365
6414PP-008P020ZP	M8	BZP-E/Galv	20	6	5023353281372
6414PP-010P025ZP	M10	BZP-E/Galv	25	6	5023353281389
6414PP-012P016ZP	M12	BZP-E/Galv	16	6	5023353281396
6414PP-016P007ZP	M16	BZP-E/Galv	7	6	5023353281402
6414PP-020P004ZP	M20	BZP-E/Galv	4	6	5023353281419

Metric Nuts & Washers - Zinc Plated

Used to secure or clamp metal, plastic or wood sheeting. DIN 934 Hex Nut & DIN 125A Form A Washer.



No.1719/PP **NEW** Retail Friendly Hanging Box

Code	Size	Finish	Pack Qty	Packs per Box	Barcode
1719PP0006ZP	M6	BZP-E/Galv	20	6	5023353048180
1719PP0008ZP	M8	BZP-E/Galv	20	6	5023353048203
1719PP0010ZP	M10	BZP-E/Galv	20	6	5023353048227
1719PP0012ZP	M12	BZP-E/Galv	10	6	5023353048241
1719PP0016ZP	M16	BZP-E/Galv	6	6	5023353048265
1719PP0020ZP	M20	BZP-E/Galv	2	6	5023353048289
1719PP0024ZP	M24	BZP-E/Galv	2	6	5023353048302

Square Plate Washers - Zinc Plated

A 3mm thick square washer offering a large surface area, spreading the load of the fixing.



No.6201 **NEW** Retail Friendly Shelf Box

Code	Size	Finish	Box Qty	Ctn Qty	Barcode
620110-050ZP	M10 x 50mm	BZP-E/Galv	100	200	5023353218934
620112-050ZP	M12 x 50mm	BZP-E/Galv	100	200	5023353275487

No.6201/PP **NEW** Retail Friendly Hanging Box

Code	Size	Finish	Pack Qty	Packs per Box	Barcode
6201PP10-050P010ZP	M10 x 50mm	BZP-E/Galv	10	6	5023353256509
6201PP12-050P010ZP	M12 x 50mm	BZP-E/Galv	10	6	5023353182808

TIMBER FIXINGS
ROOFING FIXINGS
ENGINEERED FASTENERS
MASONRY FIXINGS
NAILS

Round Metric Washers & Penny Washers

Round Metric Washers - Form A (DIN 125-A) - Zinc Plated

A standard round washer used for clamping and spacing, made from made from Grade 4.8 Mild Steel.

No.6300 **NEW** Retail Friendly Shelf Box

Code	Inside Dia.	Outside Dia.	Thickness	Finish	Box Qty	Ctn Qty	Barcode
6300-006ZP	M6	12.5mm	1.6mm	BZP-E/Galv	200	6400	5023353092138
6300-008ZP	M8	17.0mm	1.6mm	BZP-E/Galv	200	6400	5023353233395
6300-010ZP	M10	21.0mm	2.0mm	BZP-E/Galv	100	3200	5023353092176
6300-012ZP	M12	24.0mm	2.5mm	BZP-E/Galv	100	2400	5023353275470
6300-014ZP	M14	28.0mm	2.5mm	BZP-E/Galv	100	1500	5023353239113
6300-016ZP	M16	30.0mm	3.0mm	BZP-E/Galv	100	1500	5023353092237
6300-018ZP	M18	34.0mm	3.0mm	BZP-E/Galv	100	800	5023353092251
6300-020ZP	M20	37.0mm	3.0mm	BZP-E/Galv	100	800	5023353092275
6300-024ZP	M24	44.0mm	4.0mm	BZP-E/Galv	100	400	5023353092312



CORROSION RESISTANCE



PLASTIC FREE PACKAGING

No.6300/PP **NEW** Retail Friendly Hanging Box

Code	Inside Dia.	Outside Dia.	Thickness	Finish	Pack Qty	Packs per Box	Barcode
6300PP-006P100ZP	M6	12.5mm	1.6mm	BZP-E/Galv	100	6	5023353190438
6300PP-008P080ZP	M8	17.0mm	1.6mm	BZP-E/Galv	80	6	5023353190445
6300PP-010P040ZP	M10	21.0mm	2.0mm	BZP-E/Galv	40	6	5023353190452
6300PP-012P020ZP	M12	24.0mm	2.5mm	BZP-E/Galv	20	6	5023353190469
6300PP-014P020ZP	M14	28.0mm	2.5mm	BZP-E/Galv	20	6	5023353190476
6300PP-016P010ZP	M16	30.0mm	3.0mm	BZP-E/Galv	10	6	5023353190483
6300PP-018P010ZP	M18	34.0mm	3.0mm	BZP-E/Galv	10	6	5023353190490
6300PP-020P010ZP	M20	37.0mm	3.0mm	BZP-E/Galv	10	6	5023353190506
6300PP-024P010ZP	M24	44.0mm	4.0mm	BZP-E/Galv	10	6	5023353258329



Penny Washers (DIN 9054) - Zinc Plated

Penny Washers have a larger diameter to spread the load. 1.5mm thick, made from Grade 4.8 Mild Steel. Also known as Repair Washers or Mudguard Washers.

No.6350 **NEW** Retail Friendly Shelf Box

Code	Size	Finish	Box Qty	Barcode
635006-025ZP	M6 x 25mm	BZP-E/Galv	100	5023353098918
635006-032ZP	M6 x 32mm	BZP-E/Galv	100	5023353281082
635008-038ZP	M8 x 38mm	BZP-E/Galv	100	5023353228841
635010-025ZP	M10 x 25mm	BZP-E/Galv	100	5023353221712
635012-038ZP	M12 x 38mm	BZP-E/Galv	50	5023353226779



CORROSION RESISTANCE



PLASTIC FREE PACKAGING

No.6350/PP **NEW** Retail Friendly Hanging Box

Code	Size	Finish	Pack Qty	Packs per Box	Barcode
6350PP06-025P020ZP	M6 x 25mm	BZP-E/Galv	20	6	5023353192081
6350PP06-032P020ZP	M6 x 32mm	BZP-E/Galv	20	6	5023353192098
6350PP08-038P010ZP	M8 x 38mm	BZP-E/Galv	10	6	5023353257827
6350PP10-025P020ZP	M10 x 25mm	BZP-E/Galv	20	6	5023353192135
6350PP12-038P010ZP	M12 x 38mm	BZP-E/Galv	10	6	5023353192159



Assortment Packs

Lynch Pins & Rings - Yellow Passivated

Lynch Pins are fasteners used to secure equipment and machinery to trailers or vehicles for transport.



No.1300-AST01 **NEW** Retail Friendly Assortment Pack

Code	Size	Assortment Qty	Ctn Qty	Finish	Barcode
1300-AST01-YP	M4.5	12	4	Yellow Passivated	5023353275852
	M6	10			
	M8	8			
	M10	6			

Spring Cotter Pins - Zinc Plated

Used in industrial, commercial, and automotive applications to secure mechanical components to shafts or axles.



No.1301-AST01 **NEW** Retail Friendly Assortment Pack

Code	Size	Assortment Qty	Ctn Qty	Finish	Barcode
1301-AST01-ZP	2mm	75	4	Zinc Plated	5023353275869
	3mm	30			
	4mm	16			
	5mm	8			

Metric Nuts & Washers - M6-M10 - Zinc Plated

A standard Grade 8 Hex Nut with a Round Washer to suit metric threads.

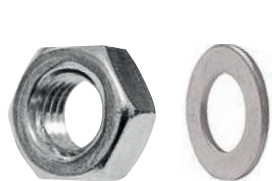

No.1719-AST01 **NEW** Retail Friendly Assortment Pack

Code	Size	Assortment Qty	Ctn Qty	Finish	Barcode
1719-AST01-ZP	M6 Nut	50	4	Zinc Plated	5023353275876
	M6 Washer	200			
	M8 Nut	30			
	M8 Washer	50			
	M10 Nut	30			
	M10 Washer	50			

Metric Nuts & Washers - M12-M20 - Zinc Plated

A standard Grade 8 Hex Nut with a Round Washer to suit metric threads.

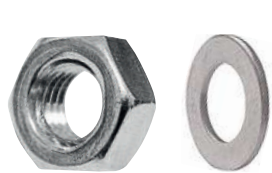

No.1719-AST02 **NEW** Retail Friendly Assortment Pack

Code	Size	Assortment Qty	Ctn Qty	Finish	Barcode
1719-AST02-ZP	M12 Nut	20	4	Zinc Plated	5023353275883
	M12 Washer	50			
	M16 Nut	10			
	M16 Washer	20			
	M20 Nut	10			
	M20 Washer	20			

Metric Spring Washers - M5-M16 - Zinc Plated

A standard Grade 8 Hex Nut with a Round Washer to suit metric threads.



No.6345-AST01 **NEW** Retail Friendly Assortment Pack

Code	Size	Assortment Qty	Ctn Qty	Finish	Barcode
6345-AST01-ZP	M5	300	6	Zinc Plated	5023353281181
	M6	200			
	M8	150			
	M10	100			
	M12	50			
	M16	20			

Flange Head & Dome Head Pop Rivets

Large Flange Head Pop Rivets (DIN 7337) - Aluminium

Used to join two or more components together from one side of the application. The large flange provides a larger surface area on the installation side of the panel.

No.6077 **NEW** Retail Friendly Shelf Box

Code	Size	Finish	Box Qty	Ctn Qty	Barcode
607748-010AL	4.8mm x 10mm	Aluminium	100	15	5023353188718
607748-012AL	4.8mm x 12mm	Aluminium	100	15	5023353188725
607748-016AL	4.8mm x 16mm	Aluminium	100	15	5023353188732
607748-024AL	4.8mm x 24mm	Aluminium	100	15	5023353188749



Dome Head Pop Rivets (DIN 7337) - Aluminium

Used to join two or more components together from one side of the application.

No.6078 **NEW** Retail Friendly Shelf Box

Code	Size	Finish	Box Qty	Ctn Qty	Barcode
607840-010AL	4mm x 10mm	Aluminium	100	32	5023353188831
607840-014AL	4mm x 14mm	Aluminium	100	32	5023353188848
607848-011AL	4.8mm x 10.9mm	Aluminium	100	32	5023353257711
607848-013AL	4.8mm x 12.7mm	Aluminium	100	32	5023353257728



Concrete & Masonry Fixings

Nylon Frame Fixings (Screw Type) - Yellow Passivated

A Nylon Plug with anti rotation lugs and a Pozi Drive Screw for fixing into concrete, concrete blocks or masonry. Traditionally used to fix timber to a wall such as a door frame. Can also be used on aerated concrete block with a limited load capacity.



No.6034 **NEW** Retail Friendly Shelf Box

Code	Driver Bit Size	Max Fixture Thickness	Size	Finish	Box Qty	Barcode
603408-060YP	PZ3	20mm	M8 x 60mm	BZP-Y/P	100	5023353257919
603408-080YP	PZ3	40mm	M8 x 80mm	BZP-Y/P	100	5023353207037
603408-100YP	PZ3	60mm	M8 x 100mm	BZP-Y/P	100	5023353199455
603408-120YP	PZ3	80mm	M8 x 120mm	BZP-Y/P	100	5023353211645
603410-100YP	PZ3	50mm	M10 x 100mm	BZP-Y/P	100	5023353203305
603410-120YP	PZ3	70mm	M10 x 120mm	BZP-Y/P	100	5023353257926
603410-140YP	PZ3	90mm	M10 x 140mm	BZP-Y/P	100	5023353206337
603410-160YP	PZ3	110mm	M10 x 160mm	BZP-Y/P	100	5023353217005

No.6034/PP **NEW** Retail Friendly Hanging Box

Code	Driver Bit Size	Max Fixture Thickness	Size	Finish	Pack Qty	Packs per Box	Barcode
6034PP08-060P010YP	PZ3	20mm	M8 x 60mm	BZP-Y/P	10	6	5023353250804
6034PP08-080P010YP	PZ3	40mm	M8 x 80mm	BZP-Y/P	10	6	5023353188015
6034PP08-100P010YP	PZ3	60mm	M8 x 100mm	BZP-Y/P	10	5	5023353188022
6034PP08-120P008YP	PZ3	80mm	M8 x 120mm	BZP-Y/P	8	5	5023353188039
6034PP10-100P008YP	PZ3	50mm	M10 x 100mm	BZP-Y/P	8	5	5023353188053
6034PP10-120P008YP	PZ3	70mm	M10 x 120mm	BZP-Y/P	8	5	5023353188060
6034PP10-140P008YP	PZ3	90mm	M10 x 140mm	BZP-Y/P	8	5	5023353188077
6034PP10-160P008YP	PZ3	110mm	M10 x 160mm	BZP-Y/P	8	5	5023353188084

Hex Head Concrete Bolts - Zinc Plated

These heavy duty, high performance Concrete Bolts are made from Grade 8.8 Boron Steel. Drill the recommended hole size into concrete, brick or stone and the bolt will self tap. Recommended for single use only.



No.6022 **NEW** Retail Friendly Shelf Box

Code	Drill Size	Max Fixture Thickness	Size	Finish	Box Qty	Ctn Qty	Barcode
602204-06050ZP	4mm	20mm	M6 x 50mm	BZP-E/Galv	100	800	5023353257544
602204-06075ZP	4mm	45mm	M6 x 75mm	BZP-E/Galv	100	800	5023353257551
602206-08050ZP	6mm	20mm	M8 x 50mm	BZP-E/Galv	100	800	5023353257568
602206-08075ZP	6mm	35mm	M8 x 75mm	BZP-E/Galv	100	600	5023353258039
602206-08100ZP	6mm	60mm	M8 x 100mm	BZP-E/Galv	100	600	5023353239083
602206-08130ZP	6mm	90mm	M8 x 130mm	BZP-E/Galv	50	400	5023353257575
602208-10060ZP	8mm	10mm	M10 x 60mm	BZP-E/Galv	50	400	5023353205590
602208-10075ZP	8mm	25mm	M10 x 75mm	BZP-E/Galv	50	400	5023353203862
602208-10100ZP	8mm	50mm	M10 x 100mm	BZP-E/Galv	50	300	5023353220838
602210-12075ZP	10mm	15mm	M12 x 75mm	BZP-E/Galv	50	300	5023353258046
602210-12100ZP	10mm	40mm	M12 x 100mm	BZP-E/Galv	25	200	5023353200786
602210-12150ZP	10mm	90mm	M12 x 150mm	BZP-E/Galv	25	150	5023353200793
602212-14100ZP	12mm	40mm	M14 x 100mm	BZP-E/Galv	25	150	5023353258053

No.6022/PP **NEW** Retail Friendly Hanging Box

Code	Drill Size	Max Fixture Thickness	Size	Finish	Pack Qty	Packs per Box	Barcode
6022PP04-06050P010ZP	4mm	20mm	M6 x 50mm	BZP-E/Galv	10	6	5023353191756
6022PP04-06075P010ZP	4mm	45mm	M6 x 75mm	BZP-E/Galv	10	6	5023353257582
6022PP06-08050P005ZP	6mm	20mm	M8 x 50mm	BZP-E/Galv	5	6	5023353257599
6022PP06-08075P005ZP	6mm	35mm	M8 x 75mm	BZP-E/Galv	5	6	5023353191763
6022PP06-08100P005ZP	6mm	60mm	M8 x 100mm	BZP-E/Galv	5	6	5023353191770
6022PP06-08130P005ZP	6mm	90mm	M8 x 130mm	BZP-E/Galv	5	5	5023353257605
6022PP08-10060P005ZP	8mm	10mm	M10 x 60mm	BZP-E/Galv	5	6	5023353191794
6022PP08-10075P005ZP	8mm	25mm	M10 x 75mm	BZP-E/Galv	5	6	5023353191800
6022PP08-10100P005ZP	8mm	50mm	M10 x 100mm	BZP-E/Galv	5	6	5023353191817
6022PP10-12075P005ZP	10mm	15mm	M12 x 75mm	BZP-E/Galv	5	6	5023353191855
6022PP10-12100P005ZP	10mm	40mm	M12 x 100mm	BZP-E/Galv	5	6	5023353191862
6022PP10-12150P005ZP	10mm	90mm	M12 x 150mm	BZP-E/Galv	5	5	5023353191886
6022PP12-14100P005ZP	12mm	40mm	M14 x 100mm	BZP-E/Galv	5	5	5023353191909

THREAD DIAMETER

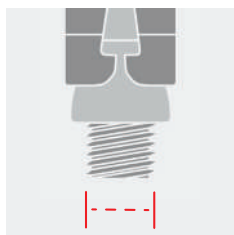

HEX

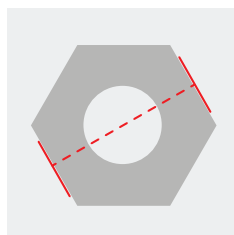

DRILL SIZE



MINIMUM DRILL DEPTH

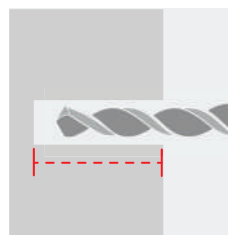

MAX FIXTURE THICKNESS

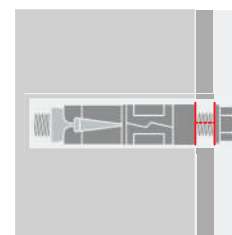

Eye Bolt Shield Anchors - Yellow Passivated

A torque controlled shield anchor for use in concrete, concrete blocks, hard stone and solid brickwork. Typical applications include supporting guy ropes, stays, cables and supporting ladder restraints.

No.6061 **NEW** Retail Friendly Shelf Box

Code	Length Under Head	Thread Diameter	Eye Diameter	Drill Size	Finish	Box Qty	Barcode
6061-006YP	80mm	M6	10mm	12mm	BZP-YP	25	5023353191947
6061-008YP	95mm	M8	11mm	14mm	BZP-YP	25	5023353191954
6061-010YP	115mm	M10	14mm	16mm	BZP-YP	25	5023353191961



No.6061/PP **NEW** Retail Friendly Hanging Box

Code	Thread Diameter	Eye Diameter	Finish	Pack Qty	Packs per Box	Barcode
6061PP-006P004YP	M6	10mm	BZP-YP	4	6	5023353191985
6061PP-008P004YP	M8	11mm	BZP-YP	4	6	5023353191992
6061PP-010P004YP	M10	14mm	BZP-YP	4	5	5023353192005



Projecting Bolt Shield Anchors - Yellow Passivated

A torque controlled shield anchor suitable for use in concrete, concrete blocks, hard stone and solid brickwork. Commonly used as a wall fixing as the projecting stud provides support during installation.

No.6028 **NEW** Retail Friendly Shelf Box

Code	Length Under Head	Thread Diameter	Drill Size	Minimum Hole Depth	Max Fixture Thickness	Finish	Box Qty	Barcode
602806-010YP	60mm	M6	12mm	50mm	10mm	BZP-YP	50	5023353258022
602808-080YP	140mm	M8	14mm	55mm	80mm	BZP-YP	25	5023353256844
602810-010YP	80mm	M10	16mm	65mm	10mm	BZP-YP	25	5023353256851
602810-030YP	100mm	M10	16mm	65mm	30mm	BZP-YP	25	5023353217043
602810-070YP	140mm	M10	16mm	65mm	70mm	BZP-YP	25	5023353256868
602812-070YP	135mm	M12	20mm	85mm	70mm	BZP-YP	10	5023353217081



No.6028/PP **NEW** Retail Friendly Hanging Box

Code	Thread Diameter	Max Fixture Thickness	Finish	Pack Qty	Packs per Box	Barcode
6028PP06-010P004YP	M6	10mm	BZP-YP	4	6	5023353256905
6028PP08-080P004YP	M8	80mm	BZP-YP	4	5	5023353256875
6028PP10-010P004YP	M10	10mm	BZP-YP	4	6	5023353256882
6028PP10-030P004YP	M10	30mm	BZP-YP	4	6	5023353256912
6028PP10-070P004YP	M10	70mm	BZP-YP	4	5	5023353256899
6028PP12-070P004YP	M12	70mm	BZP-YP	4	5	5023353256929



Shield Anchors

Loose Bolt Shield Anchors - Yellow Passivated

A torque controlled shield anchor suitable for use in concrete, concrete blocks, hard stone and solid brickwork. Commonly used as a floor fixing.



No.6027 **NEW** Retail Friendly Shelf Box

Code	Length Under Head	Thread Diameter	Drill Size	Minimum Hole Depth	Max Fixture Thickness	Finish	Box Qty	Barcode
602706-010YP	55mm	M6	12mm	50mm	10mm	BZP-YP	50	5023353281099
602708-010YP	60mm	M8	14mm	55mm	10mm	BZP-YP	50	5023353257971
602708-025YP	75mm	M8	14mm	55mm	25mm	BZP-YP	50	5023353257988
602710-010YP	70mm	M10	16mm	65mm	10mm	BZP-YP	25	5023353257995
602710-025YP	85mm	M10	16mm	65mm	25mm	BZP-YP	25	5023353258008
602710-050YP	110mm	M10	16mm	65mm	50mm	BZP-YP	25	5023353205446
602710-075YP	135mm	M10	16mm	65mm	75mm	BZP-YP	25	5023353216930
602712-025YP	100mm	M12	20mm	85mm	25mm	BZP-YP	25	5023353258015
602712-060YP	135mm	M12	20mm	85mm	60mm	BZP-YP	20	5023353216954

No.6027/PP **NEW** Retail Friendly Hanging Box

Code	Thread Diameter	Max Fixture Thickness	Finish	Pack Qty	Packs per Box	Barcode
6027PP06-010P005YP	M6	10mm	BZP-YP	5	6	5023353256769
6027PP08-010P005YP	M8	10mm	BZP-YP	5	6	5023353256776
6027PP08-025P005YP	M8	25mm	BZP-YP	5	6	5023353256783
6027PP10-010P004YP	M10	10mm	BZP-YP	4	6	5023353256585
6027PP10-025P004YP	M10	25mm	BZP-YP	4	6	5023353256790
6027PP10-050P004YP	M10	50mm	BZP-YP	4	5	5023353256806
6027PP10-075P004YP	M10	75mm	BZP-YP	4	5	5023353256813
6027PP12-025P004YP	M12	25mm	BZP-YP	4	5	5023353256820
6027PP12-060P004YP	M12	60mm	BZP-YP	4	5	5023353256837

Sleeve Anchors - Yellow Passivated

Sleeve Anchors have a torque controlled sleeve for deep set expansion into concrete, solid brickwork or stone. Can be used to join two or more concrete structures, or to fasten an object such as a shelf to a brick wall. Also known as Two-Step Bolts or Anchor Bolts.



No.6062 **NEW** Retail Friendly Shelf Box

Code	Length Under Head	Thread Diameter	Minimum Hole Depth	Max Fixture Thickness	Finish	Box Qty	Barcode
606212-060YP	60mm	M12	55mm	15mm	BZP-YP	50	5023353256936
606212-075YP	75mm	M12	55mm	27mm	BZP-YP	50	5023353256943
606212-100YP	100mm	M12	55mm	51mm	BZP-YP	25	5023353256950
606212-125YP	125mm	M12	55mm	81mm	BZP-YP	25	5023353256967

No.6062/PP **NEW** Retail Friendly Hanging Box

Code	Thread Diameter	Max Fixture Thickness	Finish	Pack Qty	Packs per Box	Barcode
6062PP12-060P004YP	M12	15mm	BZP-YP	4	6	5023353256974
6062PP12-075P004YP	M12	27mm	BZP-YP	4	6	5023353256981
6062PP12-100P004YP	M12	51mm	BZP-YP	4	6	5023353256998
6062PP12-125P004YP	M12	81mm	BZP-YP	4	5	5023353257001

TIMBER FIXINGS
ROOFING FIXINGS
ENGINEERED FASTENERS
MASONRY FIXINGS
NAILS

PERRY.

FIXINGS

NAILS



PERRY.
ROUND WIRE NAILS
40 x 2.36mm
Box Qty: 1kg
Galvanised

PERRY.
ROUND WIRE NAILS
75 x 3.35mm
Box Qty: 1kg
Galvanised

PERRY.
ROUND WIRE NAILS
100 x 4.00mm
Box Qty: 1kg
Galvanised

PERRY.
ROUND WIRE NAILS
150 x 6.00mm
Box Qty: 1kg
Galvanised

PERRY.
ROUND WIRE NAILS
125 x 5.60mm
Box Qty: 1kg
Galvanised

PERRY.
ROUND WIRE NAILS
65 x 2.65mm
Box Qty: 1kg
Galvanised

PERRY.
FIXINGS
ROUND WIRE NAILS
100 x 4.00mm Tub Qty: 2.5kg
(Approx 220pcs)
No. 6032 Self Colour
TO SCALE
100mm

PERRY.
FIXINGS
ROUND WIRE NAILS
75 x 3.35mm Tub Qty: 2.5kg
(Approx 485pcs)
No. 6032 Galvanised
TO SCALE
75mm

Round Wire Nails - Bright Self Colour

The most popular nail used by tradesmen, this general purpose nail is commonly used to fix timber to timber. Ideal for roof and floor joists.



CORROSION RESISTANCE



PLASTIC FREE PACKAGING



UKCA



No.6032/BULK

NEW

Bulk Boxed

Code	Size	Finish	Box Qty	Approx Qty per KG	Barcode
6032-040236B125SC	40mm x 2.36mm	Self Colour	12.5kg	750	5023353111242
6032-050265B125SC	50mm x 2.65mm	Self Colour	12.5kg	440	5023353111266
6032-065335B125SC	65mm x 3.35mm	Self Colour	12.5kg	230	5023353111280
6032-075335B125SC	75mm x 3.35mm	Self Colour	12.5kg	194	5023353134364
6032-075375B125SC	75mm x 3.75mm	Self Colour	12.5kg	154	5023353111310
6032-100400B125SC	100mm x 4.00mm	Self Colour	12.5kg	88	5023353111334
6032-100450B125SC	100mm x 4.50mm	Self Colour	12.5kg	77	5023353111358
6032-125560B125SC	125mm x 5.60mm	Self Colour	12.5kg	42	5023353111372
6032-150600B125SC	150mm x 6.00mm	Self Colour	12.5kg	29	5023353111396
6032-200800B125SC	200mm x 8.00mm	Self Colour	12.5kg	13	5023353117909

No.6032/RETAIL

NEW

Retail Friendly Shelf Box

Code	Size	Finish	Box Size	Ctn Qty	Barcode
6032PP040236B005SC	40mm x 2.36mm	Self Colour	0.5kg	6	5023353268960
6032PP050265B005SC	50mm x 2.65mm	Self Colour	0.5kg	6	5023353269004
6032PP065335B005SC	65mm x 3.35mm	Self Colour	0.5kg	6	5023353269006
6032PP075335B005SC	75mm x 3.35mm	Self Colour	0.5kg	6	5023353269103
6032PP075375B005SC	75mm x 3.75mm	Self Colour	0.5kg	6	5023353280108
6032PP100400B005SC	100mm x 4.00mm	Self Colour	0.5kg	6	5023353269172
6032PP100450B005SC	100mm x 4.50mm	Self Colour	0.5kg	6	5023353269219
6032PP125560B005SC	125mm x 5.60mm	Self Colour	0.5kg	6	5023353269257
6032PP150600B005SC	150mm x 6.00mm	Self Colour	0.5kg	6	5023353269295
6032PP040236B010SC	40mm x 2.36mm	Self Colour	1kg	5	5023353268984
6032PP050265B010SC	50mm x 2.65mm	Self Colour	1kg	5	5023353269028
6032PP065335B010SC	65mm x 3.35mm	Self Colour	1kg	5	5023353269080
6032PP075335B010SC	75mm x 3.35mm	Self Colour	1kg	5	5023353269127
6032PP075375B010SC	75mm x 3.75mm	Self Colour	1kg	5	5023353269158
6032PP100400B010SC	100mm x 4.00mm	Self Colour	1kg	5	5023353269196
6032PP100450B010SC	100mm x 4.50mm	Self Colour	1kg	5	5023353269233
6032PP125560B010SC	125mm x 5.60mm	Self Colour	1kg	5	5023353269271
6032PP150600B010SC	150mm x 6.00mm	Self Colour	1kg	5	5023353269249



Round Wire Nails - Bright Self Colour



CORROSION RESISTANCE



UKCA



No.6032/TUB

NEW

Retail Friendly Shelf Tub

Code	Size	Finish	Tub Size	Ctn Qty	Barcode
6032PP040236T025SC	40mm x 2.36mm	Self Colour	2.5kg	2	5023353142420
6032PP050265T025SC	50mm x 2.65mm	Self Colour	2.5kg	2	5023353142437
6032PP065335T025SC	65mm x 3.35mm	Self Colour	2.5kg	2	5023353142444
6032PP075335T025SC	75mm x 3.35mm	Self Colour	2.5kg	2	5023353142451
6032PP075375T025SC	75mm x 3.75mm	Self Colour	2.5kg	2	5023353142468
6032PP100400T025SC	100mm x 4.00mm	Self Colour	2.5kg	2	5023353142475
6032PP100450T025SC	100mm x 4.50mm	Self Colour	2.5kg	2	5023353142482
6032PP125560T025SC	125mm x 5.60mm	Self Colour	2.5kg	2	5023353142499
6032PP150600T025SC	150mm x 6.00mm	Self Colour	2.5kg	2	5023353142505

TIMBER FIXINGS
ROOFING FIXINGS
ENGINEERED FASTENERS
MASONRY FIXINGS
NAILS

Round Wire Nails - Galvanised

No.6032/BULK **NEW** Bulk Boxed

Code	Size	Finish	Box Qty	Approx Qty per KG	Barcode
6032-025180B125GV	25mm x 1.80mm	Galv'd	12.5kg	1720	5023353111884
6032-040236B125GV	40mm x 2.36mm	Galv'd	12.5kg	750	5023353111235
6032-050265B125GV	50mm x 2.65mm	Galv'd	12.5kg	440	5023353111259
6032-065265B125GV	65mm x 2.65mm	Galv'd	12.5kg	350	5023353113901
6032-065335B125GV	65mm x 3.35mm	Galv'd	12.5kg	230	5023353111273
6032-075335B125GV	75mm x 3.35mm	Galv'd	12.5kg	194	5023353111297
6032-075375B125GV	75mm x 3.75mm	Galv'd	12.5kg	154	5023353111303
6032-100400B125GV	100mm x 4.00mm	Galv'd	12.5kg	88	5023353111327
6032-100450B125GV	100mm x 4.50mm	Galv'd	12.5kg	77	5023353111341
6032-125560B125GV	125mm x 5.60mm	Galv'd	12.5kg	42	5023353111365
6032-150600B125GV	150mm x 6.00mm	Galv'd	12.5kg	29	5023353111389
6032-200800B125GV	200mm x 8.00mm	Galv'd	12.5kg	13	5023353114953



No.6032/RETAIL **NEW** Retail Friendly Shelf Box

Code	Size	Finish	Box Size	Ctn Qty	Barcode
6032PP025180B005GV	25mm x 1.80mm	Galv'd	0.5kg	6	5023353268908
6032PP040236B005GV	40mm x 2.36mm	Galv'd	0.5kg	6	5023353268953
6032PP050265B005GV	50mm x 2.65mm	Galv'd	0.5kg	6	5023353268991
6032PP065265B005GV	65mm x 2.65mm	Galv'd	0.5kg	6	5023353269035
6032PP065335B005GV	65mm x 3.35mm	Galv'd	0.5kg	6	5023353269059
6032PP075335B005GV	75mm x 3.35mm	Galv'd	0.5kg	6	5023353269097
6032PP075375B005GV	75mm x 3.75mm	Galv'd	0.5kg	6	5023353269134
6032PP100400B005GV	100mm x 4.00mm	Galv'd	0.5kg	6	5023353269165
6032PP100450B005GV	100mm x 4.50mm	Galv'd	0.5kg	6	5023353269202
6032PP125560B005GV	125mm x 5.60mm	Galv'd	0.5kg	6	5023353269240
6032PP150600B005GV	150mm x 6.00mm	Galv'd	0.5kg	6	5023353269288
6032PP025180B010GV	25mm x 1.80mm	Galv'd	1kg	5	5023353268922
6032PP040236B010GV	40mm x 2.36mm	Galv'd	1kg	5	5023353268977
6032PP050265B010GV	50mm x 2.65mm	Galv'd	1kg	5	5023353269011
6032PP065265B010GV	65mm x 2.65mm	Galv'd	1kg	5	5023353269042
6032PP065335B010GV	65mm x 3.35mm	Galv'd	1kg	5	5023353269073
6032PP075335B010GV	75mm x 3.35mm	Galv'd	1kg	5	5023353269110
6032PP075375B010GV	75mm x 3.75mm	Galv'd	1kg	5	5023353269144
6032PP100400B010GV	100mm x 4.00mm	Galv'd	1kg	5	5023353269189
6032PP100450B010GV	100mm x 4.50mm	Galv'd	1kg	5	5023353269226
6032PP125560B010GV	125mm x 5.60mm	Galv'd	1kg	5	5023353269264
6032PP150600B010GV	150mm x 6.00mm	Galv'd	1kg	5	5023353269301



Round Wire Nails - Galvanised

No.6032/TUB **NEW** Retail Friendly Shelf Tub

Code	Size	Finish	Tub Size	Ctn Qty	Barcode
6032PP025180T025GV	25mm x 1.80mm	Galv'd	2.5kg	2	5023353142529
6032PP040236T025GV	40mm x 2.36mm	Galv'd	2.5kg	2	5023353142536
6032PP050265T025GV	50mm x 2.65mm	Galv'd	2.5kg	2	5023353142543
6032PP065265T025GV	65mm x 2.65mm	Galv'd	2.5kg	2	5023353142550
6032PP065335T025GV	65mm x 3.35mm	Galv'd	2.5kg	2	5023353142567
6032PP075335T025GV	75mm x 3.35mm	Galv'd	2.5kg	2	5023353142574
6032PP075375T025GV	75mm x 3.75mm	Galv'd	2.5kg	2	5023353142581
6032PP100400T025GV	100mm x 4.00mm	Galv'd	2.5kg	2	5023353142598
6032PP100450T025GV	100mm x 4.50mm	Galv'd	2.5kg	2	5023353142604
6032PP125560T025GV	125mm x 5.60mm	Galv'd	2.5kg	2	5023353142611
6032PP150600T025GV	150mm x 6.00mm	Galv'd	2.5kg	2	5023353142628
6032PP040236T050GV	40mm x 2.36mm	Galv'd	5kg	2	5023353108266
6032PP050265T050GV	50mm x 2.65mm	Galv'd	5kg	2	5023353135446
6032PP065265T050GV	65mm x 2.65mm	Galv'd	5kg	2	5023353107306
6032PP065335T050GV	65mm x 3.35mm	Galv'd	5kg	2	5023353101267
6032PP075335T050GV	75mm x 3.35mm	Galv'd	5kg	2	5023353106453
6032PP075375T050GV	75mm x 3.75mm	Galv'd	5kg	2	5023353101984
6032PP100400T050GV	100mm x 4.00mm	Galv'd	5kg	2	5023353103445
6032PP100450T050GV	100mm x 4.50mm	Galv'd	5kg	2	5023353100680
6032PP125560T050GV	125mm x 5.60mm	Galv'd	5kg	2	5023353102776
6032PP150600T050GV	150mm x 6.00mm	Galv'd	5kg	2	5023353099694
6032PP075335T100GV	75mm x 3.35mm	Galv'd	10kg	1	5023353281785
6032PP100400T100GV	100mm x 4.00mm	Galv'd	10kg	1	5023353281792



Annular Ring Shank Nails - Bright Self Colour

A threaded nail with a high withdrawal resistance. Commonly used in the manufacture of wooden pallets, crates and packing cases.



CORROSION RESISTANCE



PLASTIC FREE PACKAGING



No.6048/BULK **NEW** Bulk Boxed

Code	Size	Finish	Box Qty	Approx Qty per KG	Barcode
6048-025200B125SC	25mm x 2.00mm	Self Colour	12.5kg	1430	5023353111747
6048-040265B125SC	40mm x 2.65mm	Self Colour	12.5kg	575	5023353111778
6048-050265B125SC	50mm x 2.65mm	Self Colour	12.5kg	440	5023353111792
6048-065335B125SC	65mm x 3.35mm	Self Colour	12.5kg	230	5023353111815
6048-075375B125SC	75mm x 3.75mm	Self Colour	12.5kg	154	5023353111839

No.6048/RETAIL **NEW** Retail Friendly Shelf Box

Code	Size	Finish	Box Size	Ctn Qty	Barcode
6048PP025200B005SC	25mm x 2.00mm	Self Colour	0.5kg	6	5023353270161
6048PP040265-005SC	40mm x 2.65mm	Self Colour	0.5kg	6	5023353270239
6048PP050265-005SC	50mm x 2.65mm	Self Colour	0.5kg	6	5023353270277
6048PP065335B005SC	65mm x 3.35mm	Self Colour	0.5kg	6	5023353270314
6048PP075375B-005SC	75mm x 3.75mm	Self Colour	0.5kg	6	5023353270352
6048PP025200B010SC	25mm x 2.00mm	Self Colour	1kg	5	5023353270185
6048PP040265B010SC	40mm x 2.65mm	Self Colour	1kg	5	5023353270253
6048PP050265B010SC	50mm x 2.65mm	Self Colour	1kg	5	5023353270291
6048PP065335B010SC	65mm x 3.35mm	Self Colour	1kg	5	5023353270338
6048PP075375B010SC	75mm x 3.75mm	Self Colour	1kg	5	5023353270376



Annular Ring Shank Nails - Sheradised



CORROSION RESISTANCE



PLASTIC FREE PACKAGING



No.6048/BULK **NEW** Bulk Boxed

Code	Size	Finish	Box Qty	Approx Qty per KG	Barcode
6048-030236B125SH	30mm x 2.36mm	Sheradised	12.5kg	840	5023353111761
6048-040265B125SH	40mm x 2.65mm	Sheradised	12.5kg	575	5023353111785
6048-050265B125SH	50mm x 2.65mm	Sheradised	12.5kg	440	5023353111808
6048-075375B125SH	75mm x 3.75mm	Sheradised	12.5kg	154	5023353111846

No.6048/RETAIL **NEW** Retail Friendly Shelf Box

Code	Size	Finish	Box Size	Ctn Qty	Barcode
6048PP030236B005SH	30mm x 2.36mm	Sheradised	0.5kg	6	5023353270208
6048PP040265B005SH	40mm x 2.65mm	Sheradised	0.5kg	6	5023353270246
6048PP050265B005SH	50mm x 2.65mm	Sheradised	0.5kg	6	5023353270284
6048PP075375B005SH	75mm x 3.75mm	Sheradised	0.5kg	6	5023353270369
6048PP030236B010SH	30mm x 2.36mm	Sheradised	1kg	5	5023353270222
6048PP040265B010SH	40mm x 2.65mm	Sheradised	1kg	5	5023353270260
6048PP050265B010SH	50mm x 2.65mm	Sheradised	1kg	5	5023353270307
6048PP075375B010SH	75mm x 3.75mm	Sheradised	1kg	5	5023353270383



TIMBER FIXINGS

ROOFING FIXINGS

ENGINEERED FASTENERS

MASONRY FIXINGS

NAILS

Pointed (Netting) Wire Staples - Galvanised

Commonly used to fix wire, wire fencing or wire netting to wooden posts.

No.6033/BULK **NEW** Bulk Boxed

Code	Size	Finish	Box Qty	Approx Qty per KG	Barcode
6033-020200B125GV	20mm x 2.00mm	Galv'd	12.5kg	930	5023353111419
6033-025265B125GV	25mm x 2.65mm	Galv'd	12.5kg	480	5023353111426
6033-030355B125GV	30mm x 3.55mm	Galv'd	12.5kg	240	5023353111433
6033-040400B125GV	40mm x 4.00mm	Galv'd	12.5kg	135	5023353111440
6033-050500B125GV	50mm x 5.00mm	Galv'd	12.5kg	72	5023353169496



No.6033/RETAIL **NEW** Retail Friendly Shelf Box

Code	Size	Finish	Box Size	Ctn Qty	Barcode
6033PP020200B005GV	20mm x 2.00mm	Galv'd	0.5kg	6	5023353269370
6033PP025265B005GV	25mm x 2.65mm	Galv'd	0.5kg	6	5023353269394
6033PP030355B005GV	30mm x 3.55mm	Galv'd	0.5kg	6	5023353269417
6033PP040400B005GV	40mm x 4.00mm	Galv'd	0.5kg	6	5023353296431
6033PP050500B005GV	50mm x 5.00mm	Galv'd	0.5kg	6	5023353269455
6033PP020200B010GV	20mm x 2.00mm	Galv'd	1kg	5	5023353269387
6033PP025265B010GV	25mm x 2.65mm	Galv'd	1kg	5	5023353269400
6033PP030355B010GV	30mm x 3.55mm	Galv'd	1kg	5	5023353269424
6033PP040400B010GV	40mm x 4.00mm	Galv'd	1kg	5	5023353269448
6033PP050500B010GV	50mm x 5.00mm	Galv'd	1kg	5	5023353269462



Pointed (Netting) Wire Staples - Galvanised

No.6033/TUB **NEW** Retail Friendly Shelf Tub

Code	Size	Finish	Tub Size	Ctn Qty	Barcode
6033PP020200T025GV	20mm x 2.00mm	Galv'd	2.5kg	2	5023353142857
6033PP025265T025GV	25mm x 2.65mm	Galv'd	2.5kg	2	5023353142864
6033PP030355T025GV	30mm x 3.55mm	Galv'd	2.5kg	2	5023353142871
6033PP040400T025GV	40mm x 4.00mm	Galv'd	2.5kg	2	5023353142888
6033PP050500T025GV	50mm x 5.00mm	Galv'd	2.5kg	2	5023353142895



Panel Pins - Bright Self Colour

A small, thin nail extensively used in DIY, beading, picture frames and furniture backboards.



No.6036/RETAIL **NEW** Retail Friendly Shelf Box

Code	Size	Finish	Box Qty	Ctn Qty	Barcode
6036PP025160B005SC	25mm x 1.60mm	Self Colour	0.5kg	6	5023353269523
6036PP030160B005SC	30mm x 1.60mm	Self Colour	0.5kg	6	5023353269554
6036PP040160B005SC	40mm x 1.60mm	Self Colour	0.5kg	6	5023353269585

Oval Brad Nails - Bright Self Colour

Used where the fixing needs to be concealed, these nails can be tapped below the surface of the wood and reduces the risk of the timber splitting. Frequently used on floor boards, door jambs and skirting boards.



No.6037/BOX **NEW** Bulk Boxed

Code	Size	Finish	Box Qty	Approx Qty per KG	Barcode
6037-040B125SC	40mm	Self Colour	12.5kg	940	5023353111518

No.6037/RETAIL **NEW** Retail Friendly Shelf Box

Code	Size	Finish	Box Size	Ctn Qty	Barcode
6037PP040B005SC	40mm	Self Colour	0.5kg	6	5023353269646

Square Twisted Nails - Galvanised

For use with builders ironwork, these nails are suitable for fixing joists and restraint straps. The square, twisted shank gives a strong grip with high resistance to withdrawal.

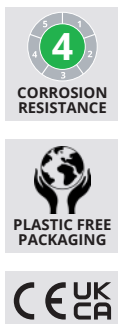

No.6045/BOX **NEW** Bulk Boxed

Code	Size	Finish	Box Qty	Approx Qty per KG	Barcode
6045-030375B125GV	30mm x 3.75mm	Galv'd	12.5kg	750	5023353111709

No.6045/RETAIL **NEW** Retail Friendly Shelf Box

Code	Size	Finish	Box Size	Ctn Qty	Barcode
6045PP030375B005GV	30mm x 3.75mm	Galv'd	0.5kg	6	5023353270086
6045PP030375B010GV	30mm x 3.75mm	Galv'd	1kg	5	5023353270093

Clout Nails - Galvanised

With a larger head than a standard nail, Clout Nails are used on a variety of exterior applications, including the fixing of roofing felt, plastic sheeting, roof tiles and slate. Also known as Felt Nails.

No.6038/BULK **NEW** Bulk Boxed

Code	Size	Finish	Box Qty	Approx Qty per KG	Barcode
6038-025265B125GV	25mm x 2.65mm	Galv'd	12.5kg	815	5023353111563
6038-030265B125GV	30mm x 2.65mm	Galv'd	12.5kg	660	5023353111570
6038-040265B125GV	40mm x 2.65mm	Galv'd	12.5kg	570	5023353111587
6038-050335B125GV	50mm x 3.35mm	Galv'd	12.5kg	290	5023353111594
6038-065375B125GV	65mm x 3.75mm	Galv'd	12.5kg	180	5023353111600



No.6038/RETAIL **NEW** Retail Friendly Shelf Box

Code	Size	Finish	Box Size	Ctn Qty	Barcode
6038PP012265B005GV	12mm x 2.65mm	Galv'd	0.5kg	6	5023353273667
6038PP020265B005GV	20mm x 2.65mm	Galv'd	0.5kg	6	5023353273674
6038PP025265B005GV	25mm x 2.65mm	Galv'd	0.5kg	6	5023353269745
6038PP030265B005GV	30mm x 2.65mm	Galv'd	0.5kg	6	5023353269769
6038PP040265B005GV	40mm x 2.65mm	Galv'd	0.5kg	6	5023353269783
6038PP050335B005GV	50mm x 3.35mm	Galv'd	0.5kg	6	5023353275432
6038PP065375B005GV	65mm x 3.75mm	Galv'd	0.5kg	6	5023353269820

Extra Large Head Clout Nails - Galvanised

With a larger head than a standard Clout Nail, Extra Large Head Clout Nails are used on a variety of exterior applications, including the fixing of roofing felt, plastic sheeting, roof tiles and slate. Also known as Felt Nails.

No.6043/BULK **NEW** Bulk Boxed

Code	Size	Finish	Box Qty	Approx Qty per KG	Barcode
6043-013300B125GV	13mm x 3.00mm	Galv'd	12.5kg	780	5023353111662
6043-020300B125GV	20mm x 3.00mm	Galv'd	12.5kg	580	5023353111679
6043-030300B125GV	30mm x 3.00mm	Galv'd	12.5kg	420	5023353111686
6043-040300B125GV	40mm x 3.00mm	Galv'd	12.5kg	350	5023353111693



No.6043/RETAIL **NEW** Retail Friendly Shelf Box

Code	Size	Finish	Box Size	Ctn Qty	Barcode
6043PP013300B005GV	13mm x 3.00mm	Galv'd	0.5kg	6	5023353270017
6043PP020300B005GV	20mm x 3.00mm	Galv'd	0.5kg	6	5023353270031
6043PP030300B005GV	30mm x 3.00mm	Galv'd	0.5kg	6	5023353275425
6043PP040300B005GV	40mm x 3.00mm	Galv'd	0.5kg	6	5023353270062

Extra Large Head Clout Nails - Galvanised

No.6043/TUB **NEW** Retail Friendly Shelf Tub

Code	Size	Finish	Tub Size	Ctn Qty	Barcode
6043PP013300T025GV	13mm x 3.00mm	Galv'd	2.5kg	2	5023353142734
6043PP020300T025GV	20mm x 3.00mm	Galv'd	2.5kg	2	5023353142741
6043PP030300T025GV	30mm x 3.00mm	Galv'd	2.5kg	2	5023353141935
6043PP040300T025GV	40mm x 3.00mm	Galv'd	2.5kg	2	5023353142772



Loose Nails & Dowty Washers

Round Head Drive Screw Nails - Galvanised

Commonly used to fix roofing and cladding sheets to timber. Can be used with a Dowty Washer (sold separately) to create a watertight seal.



No.6044/RETAIL **NEW** Retail Friendly Shelf Box

Code	Size	Finish	Box Size	Ctn Qty	Barcode
6044PP100016B010GV	100mm x 16 Gauge	Galv'd	1kg	5	5023353273643
6044PP125016B010GV	125mm x 16 Gauge	Galv'd	1kg	5	5023353273650

Spring Head Roofing Nails - Galvanised

Commonly used for securing corrugated roofing sheets and cladding sheets to timber. Can be used with a Dowty Washer (sold separately) to create a watertight seal.



No.6049/BULK **NEW** Bulk Boxed

Code	Size	Finish	Box Qty	Approx Qty per KG	Barcode
6049-065335B100GV	65mm x 3.35mm	Galv'd	10kg	140	5023353095344

No.6049/RETAIL **NEW** Retail Friendly Shelf Box

Code	Size	Finish	Box Size	Ctn Qty	Barcode
6049PP065335B005GV	65mm x 3.35mm	Galv'd	0.5kg	6	5023353270475
6049PP065335B010GV	65mm x 3.35mm	Galv'd	1kg	5	5023353270482

Spring Head Roofing Nails - Galvanised



No.6049/TUB **NEW** Retail Friendly Shelf Tub

Code	Size	Finish	Tub Size	Ctn Qty	Barcode
6049PP065335T025GV	65mm x 3.35mm	Galv'd	2.5kg	2	5023353142819

Dowty Type Washers (Spat Washers) - Black

Commonly used with Drive Screw Nails and Spring Head Roofing Nails to provide a watertight seal when fixing corrugated roofing sheets to wood.



No.6205 **NEW** Retail Friendly Hanging Box

Code	Size	Finish	Box Qty	Ctn Qty	Barcode
62050006BK	6mm	Black	100	800	5023353192029
62050008BK	8mm	Black	100	800	5023353192036

ALSO AVAILABLE BRAND NEW
PREPACK HARDWARE

95%
OF PLASTIC
REMOVED

**50% Total Reduction
of Packaging Waste**

**All Packaging 100%
Recyclable Material**

**Enhanced Product
Visibility**

SAY NO TO PLASTIC

BEFORE

AFTER



**SUSTAINABILITY INITIATIVE
OF THE YEAR WINNER**



**NET ZERO
CLUB**

UP TO DOUBLE THE STOCK ON THE SAME DISPLAY

PERRY®

FIXINGS®

A. Perry Ltd

Doulton Road | Cradley Heath | West Midlands | B64 5QW
Tel: +44 (0)1384 414001 | Email: sales@perrytrade.co.uk

www.perrytrade.co.uk

PERRY
PLASTIC FREE

PERRY

FIXINGS

CUP SQUARE BOLTS WITH NUTS (DIN 603/555)

M12 x 150_{mm}

Box Qty: 5



Zinc Plated



CUP SQUARE BOLTS WITH NUTS (DIN 603/555)

M12 x 100_{mm}

Box Qty: 5



Zinc Plated



A security bolt that has a separate nut for extra security. The nut is made of a different material to the bolt and is supplied with the bolt. The nut is made of a different material to the bolt and is supplied with the bolt. The nut is made of a different material to the bolt and is supplied with the bolt.

HOOK BOLTS

M8 x 120_{mm}

Box Qty: 5



HOOK BOLTS

M8 x 100_{mm}

Box Qty: 5

